

Singer 15-96

Singer 15-97

Singer 15-98

Form 19603
(1140)
Printed in U. S. A.

LIST OF PARTS



FOR FAMILY SHOPS

MACHINES
Nos. 15-96, 15-97 and 15-98

THE SINGER MANUFACTURING COMPANY

INDEX

**Genuine Singer Needles should be used
 in Singer Machines.
 These Needles and their Containers
 are marked with the
 Company's Trade Mark "SIMANCO." 1**

**Needles in Containers marked
 "For Singer Machines"
 are not Singer made needles. 2**

| | Page |
|--|------|
| Accessories..... | 27 |
| Attachment Set..... | 27 |
| Bias Gauge..... | 28 |
| Bobbin Winder..... | 28 |
| Braider..... | 29 |
| Controllers (Bakelite)..... | 16 |
| Controller Holder..... | 17 |
| Corder (Bow)..... | 29 |
| Feed Cover Plate..... | 29 |
| Feller (Foot)..... | 29 |
| Finger Guard..... | 29 |
| Foot Controllers (Bakelite)..... | 14 |
| Hemmer (Foot)..... | 29 |
| Hemstitcher..... | 30 |
| Knee Lever Parts..... | 18 |
| Machine No. 15-96..... | 5 |
| " " 15-97..... | 10 |
| " " 15-98..... | 11 |
| Motor Parts..... | 12 |
| Numerical List of Parts..... | 33 |
| Ruffler Shirring Plate..... | 31 |
| Quilter..... | 31 |
| Presser Feet..... | 30 |
| Presser Foot with Graduated Adjustable Guides..... | 30 |
| Singerlight No. 193294..... | 23 |
| " " 193518..... | 26 |
| " " Lamp..... | 27 |
| Special Attachments..... | 32 |
| Treadle Controllers for Stands Nos. 25281, 25282 and 25294..... | 19 |
| Treadle Controllers for Stands Nos. 46909, 46912 and 46913..... | 20 |
| Under Braider..... | 31 |

From the library of: Diamond Needle Corp.

INSTRUCTIONS FOR ORDERING

5

In ordering from this list, use ONLY the part NUMBER in the FIRST column.

The number stamped on a Sewing Machine Part is in every case the number of the single part only.

Every combination of parts sent out as such has its specific number, which, although not stamped on the parts, must be used when ordering the combination.

Each number always indicates the SAME PART in whatever list it appears, or for whatever machine.

The letters after some of the numbers indicate the style of finish only, as follows:

- A-Hardened, Polished, Nickel Plated and Buffed
- A.A-Buffed and Chromium Plated
- A.B-Hardened, Polished, Buffed and Chromium Plated
- A.C-Brown Baking Enamel Finish
- A.D-Gray Baking Enamel Finish
- A.E-Hardened, Bright Rumbled and Nickel Plated
- A.F-Hardened, Bright Rumbled, Nickel Plated, Bright Rumbled and Chromium Plated
- B-Polished, Nickel Plated and Buffed
- C-Hardened Only
- C.R-Hardened and Merlized
- D-Polished Only
- E-Soft, Not Polished
- F-Hardened and Polished
- F.J-Hardened, Polished and Nickel Plated
- G-Bright Rumbled and Nickel Plated
- H-Blued
- J-Nickel Plated Only
- K-Hardened and Nickel Plated
- L-Brass Plated
- M-Oxidized
- N-Japanned, Dull
- P-Japanned, Bright
- P.P-Wrinkle Finish
- R-Merlized
- S-Cadmium Plated
- T-Copper Plated
- T.A-Hardened, Polished, Copper and Nickel Plated and Buffed
- T.B-Copper and Nickel Plated and Polished
- T.J-Copper and Nickel Plated Only
- T.K-Hardened, Copper and Nickel Plated
- T.L-Copper and Brass Plated
- T.M-Copper Plated and Oxidized
- U-Zinc Plated
- V-Silver Plated
- W-Polished and Nickel Plated
- X-Black Oxide, for Iron and Steel
- X.C-Hardened and Black Oxide, for Iron or Steel
- Y-Black Nickel Plated Only
- Z-Chromium Plated
- Z.A-Hardened, Polished, Nickel Plated, Buffed and Chromium Plated
- Z.B-Polished, Nickel Plated, Buffed and Chromium Plated
- Z.C-Hardened and Chromium Plated
- Z.D-Polished and Chromium Plated
- Z.G-Bright Rumbled, Nickel Plated, Bright Rumbled and Chromium Plated
- Z.H-Nickel and Chromium Plated
- Z.I-Copper and Chromium Plated

These letters MUST BE USED when they appear in the list; and AFTER the number as in the list.

In this series:

- 1 to 1500, 50001 to 51500 and 140001 to 142000 are Screw Numbers
- 1501 to 1800 and 51501 to 51800 are Nut Numbers
- 1801 to 2000 and 51801 to 52000 are Roller Numbers
- 2001 to 50000 and 52001 to 140000 and 142001 to 190000 are Sewing Machine Parts, 190001 and upward are numbers of Electrical Parts.

The figures in the second column refer only to the plates, illustrating the parts, and are NOT TO BE USED in ordering.

Parts marked with an asterisk (*) are furnished only when repairs are made at factory.

LIST OF PARTS COMPLETE

FOR

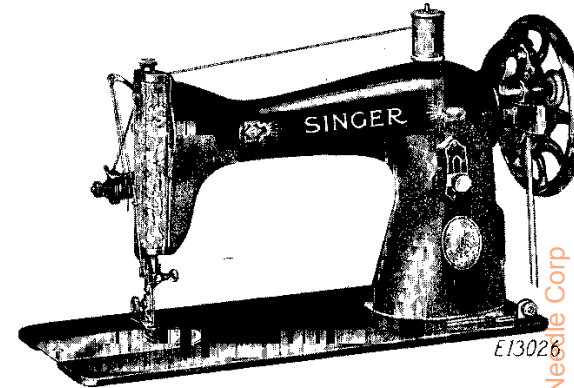

MACHINE No. 15-96

FOR FAMILY USE. C. B. SHUTTLE. DROP FEED.
BALANCED MACHINE.

| No. | Plate | Name |
|---------|-------|---|
| *125106 | ---- | Arm with 435C, 448C, 15404, 15486, 15498 and two 15405..... |
| 2002 | 21471 | Arm Dowel Pin (2)..... |
| 125331 | 21471 | " Oil Pad (felt) for oiling Arm Shaft Back Bearing..... |
| 125333 | 21471 | Arm Oil Pad Spring..... |
| 125334 | 21471 | " " " " Cap..... |
| 138E | 21471 | " Screw (2)..... |
| 125042 | 21471 | " Shaft..... |
| 15498 | 21471 | " " Bushing..... |
| 435C | 21471 | " " " Set Screw..... |
| 125425 | 21471 | " Side Cover..... |
| 51224B | 21471 | " " " Thumb Screw..... |
| 2007 | 21471 | " Spool Pin..... |
| 8879 | 21471 | " " " Washer (cloth)..... |
| 15282 | 21471 | Balance Wheel, 2 1/4 in. pulley..... |
| *125107 | ---- | Bed..... |
| 256B | 21471 | Clamp Stop Motion Clamp Screw..... |

Library of: Diamond Needle Corp

| No. | Plate | Name |
|--------|-------|--|
| 248A | 21471 | Clamp Stop Motion Clamp Stop Screw..... |
| 2020 | 21471 | " " " " Washer..... |
| 15313 | 21471 | " " " Flanged Bushing with two 462C..... |
| 462C | 21471 | Clamp Stop Motion Flanged Bushing Set Screw (2)..... |
| 15314 | 21471 | Clamp Stop Motion complete, Nos. 248A, 256B, 2020 and 15313..... |
| 125021 | 21471 | Crank Connecting Rod with 125044 and two 896C..... |
| 896C | 21471 | Crank Connecting Rod Cap Screw..... |
| 375C | 21471 | " " " Hinge Screw..... |
| 1518J | 21471 | " " " " Nut.... |
| 125044 | 21471 | " " " " 011 Pad (felt).... |
| 15432 | 21474 | Face Plate with 857B,15410,15412,15428, 50292B and 125423..... |
| 15408 | ----- | Face Plate Tension Seat..... |
| 15428 | 21474 | " " " " 15408 with 15395 |
| 55644 | 21474 | Face Plate complete, Nos. 15432 and 15471..... |
| 190B | 21474 | Face Plate Screw..... |
| 125422 | ----- | " " Thread Guard..... |
| 125423 | 21474 | " " " " 125422 with 125424 |
| 125424 | ----- | " " " " Rivet..... |
| 2835 | 21472 | Feed Bar..... |
| 315C | 21472 | " " Screw Center..... |
| 15445 | ----- | " " " " 315C with 1519J (2) |
| 1519J | 21472 | " " " " Nut..... |
| 125045 | 21471 | " Cam and Counterbalance with 1285C.. |
| 1285C | 21471 | " " " " Position Screw |
| 15279 | 21474 | " Dog,12 teeth (14 teeth to the inch) for 15280, 15316 and 15317..... |
| 208E | 21474 | Feed Dog Screw (2)..... |
| 125046 | 21471 | " Forked Connection..... |
| 125085 | ----- | " " " " 125046 with 125335 |
| 1381C | 21471 | " " " " Hinge Screw (ec- centric)..... |
| 1520J | 21471 | Feed Forked Connection Hinge Screw Nut.. |
| 125047 | 21471 | " " " " Slide Block..... |
| 125335 | ----- | " " " " " 125047 with 1085E..... |
| 1085E | 21471 | Feed Forked Connection Slide Block Screw Stud..... |
| 2816 | 21472 | Feed Lifting Rock Shaft..... |
| 2836 | ----- | Feed Lifting Rock Shaft complete, Nos. 2509 and 2816..... |
| 2509 | 21472 | Feed Lifting Rock Shaft Crank with 157J and 1813..... |
| 157J | 21472 | Feed Lifting Rock Shaft Crank Clamping Screw..... |

| No. | Plate | Name |
|--------|-------|---|
| 1813 | 21472 | Feed Lifting Rock Shaft Crank Roller and Stud..... |
| 307C | 21472 | Feed Lifting Rock Shaft Screw Center.... |
| 56814 | ----- | " " " " " 307C with 1513J (2)..... |
| 1513J | 21472 | Feed Lifting Rock Shaft Screw Center Nut |
| 125101 | 21471 | " Regulator..... |
| 8217 | 21471 | " " Friction Washer..... |
| 50353E | 21471 | " " Hinge Screw..... |
| 51225B | 21471 | " " Thumb Screw..... |
| 15297 | 21472 | " Rock Shaft..... |
| 307C | 21472 | " " " Screw Center..... |
| 56814 | ----- | " " " " " 307C with 1513J (2)..... |
| 1513J | 21472 | Feed Rock Shaft Screw Center Nut..... |
| 51045C | 21471 | Machine Hinge Connection Set Screw.... |
| 125079 | 21471 | Needle Bar..... |
| 125052 | 21471 | " " Bushing..... |
| 125072 | 21471 | " " " " 011 Pad (felt).... |
| 1498C | 21471 | " " " " Set Screw..... |
| 15248 | 21471 | " " Connecting Link with 51002E.. |
| 15374 | ----- | " " " " " 15248 with 2052..... |
| 51002E | 21471 | Needle Bar Connecting Link Adjusting Screw..... |
| 570C | 21471 | Needle Bar Connecting Link Hinge Screw.. |
| 1520R | 21471 | " " " " " Nut |
| 2052 | 21471 | " " " " Stud with 153C |
| 155C | 21471 | " " " " Set Screw.... |
| 125095 | 21471 | " " Thread Guard..... |
| 251A | 21471 | " " " " Screw..... |
| 2054 | 21471 | " Clamp with 552C..... |
| 552C | 21471 | " " Thumb Screw..... |
| 125055 | 21472 | Oscillating Rock Shaft with 125056.... |
| 125056 | 21472 | " " " " Oil Wick (braided cotton)..... |
| 307C | 21472 | Oscillating Rock Shaft Screw Center.... |
| 56814 | ----- | " " " " " 307C with 1513J (2)..... |
| 1513J | 21472 | Oscillating Rock Shaft Screw Center Nut. |
| 2510 | 21472 | " Shaft..... |
| 125057 | 21472 | " " Crank..... |
| 125059 | ----- | " " " " 125057 with 125330 and two 462C..... |
| 462C | 21472 | Oscillating Shaft Crank Set Screw (2)... |
| 125330 | 21472 | " " " " Slide Block with Stud..... |
| 125061 | 21471 | Presser Bar..... |
| 55621 | 21471 | " " Lifter..... |
| 15486 | 21471 | " " " Hinge Stud..... |

From the Library: Digitized by eGangotri

| No. | Plate | Name |
|---------|-------|--|
| 448C | 21471 | Presser Bar Lifter Hinge Stud Set Screw. |
| 80011 | 21471 | " " Spring..... |
| 2068 | 21471 | " " " Bracket with 453C.... |
| 453C | 21471 | " " " " Set Screw.... |
| 2070 | 21471 | " " " Washer..... |
| 45329 | 21474 | " Foot Hinge Pin..... |
| 45319 | 21474 | " " Plate..... |
| 45320 | 21474 | " " Shank..... |
| 45321 | 21474 | Presser Foot (hinged) complete, Nos. 45319, 45320 and 45329..... |
| 51224B | 21474 | Presser Foot Thumb Screw..... |
| 51228ZJ | 21471 | Pressure Regulating Thumb Screw..... |
| 66773 | ----- | " " " " 51228ZJ with 66752..... |
| 66752 | 21471 | Pressure Regulating Thumb Screw Plug (felt)..... |
| 2518 | 21473 | Shuttle Bobbin..... |
| 15140 | 21473 | " " Case Latch..... |
| 2973 | 21473 | " " " " Lever..... |
| 2974 | 21473 | " " " " Fulcrum Pin..... |
| 2975 | 21473 | Shuttle Bobbin Case Latch Spring..... |
| 592E | 21473 | " " " " Stop Screw.... |
| 15141 | 21473 | Shuttle Bobbin Case Hinge, Nos. 2973, 2974 and 15140..... |
| 15277 | 21473 | Shuttle Bobbin Case complete, Nos. 591F, 592E, 2975, 15141 and 15278..... |
| 2515 | 21473 | Shuttle Body..... |
| 591F | 21473 | " Tension Regulating Screw..... |
| 15278 | 21473 | " " Spring..... |
| 125018 | 21473 | " 1 11/16 in. diam., Nos. 2515, 2518 and 15277..... |
| 125064 | 21472 | Shuttle Driver with 125065 and two each 462C and 51229E..... |
| 125065 | 21472 | Shuttle Driver Cushion Spring..... |
| 51229E | 21472 | " " " " Screw (2). |
| 462C | 21472 | " " Set Screw (2)..... |
| 2531 | 21473 | " Race Back..... |
| 2532 | 21473 | " " " Position Pin (2)..... |
| 125080 | 21473 | " " " Spring..... |
| 648J | 21473 | " " " " Screw..... |
| 2530 | 21473 | " " Body..... |
| 15420 | 21473 | " " " 2530 with 2535 and two 662J..... |
| 2535 | 21473 | Shuttle Race Cap..... |
| 662J | 21473 | " " " Screw (2)..... |
| 2528 | 21473 | Shuttle Race complete, Nos. 648J, 2531, 15420, 125080 and two 2532..... |
| 145J | 21473 | Shuttle Race Screw (2)..... |
| 15188 | 21474 | " " Slide..... |

| No. | Plate | Name |
|---|-------|--|
| 2824 | 21474 | Shuttle Race Slide Spring..... |
| 51282J | 21474 | " " " " Screw..... |
| 15147 | 21474 | Shuttle Race Slide complete, Nos. 2824, 15188 and two 51282J..... |
| 125103 | 21471 | Stitch Indicator..... |
| 125104 | 21471 | " " " Plate..... |
| 140202S | 21471 | " " " " Screw (2)..... |
| 2102 | 21474 | Tension Disc..... |
| 1560B | 21474 | " Regulating Thumb Nut..... |
| 32572 | 21474 | " Releasing Disc..... |
| 15238 | 21474 | " " Pin..... |
| 13710 | 21474 | " Spring..... |
| 50291W | 21474 | " Stud..... |
| 15410 | ----- | " " Bushing..... |
| 50292B | 21474 | " " Set Screw..... |
| 15471 | ----- | Tension complete, Nos. 1560B, 13710, 15238, 32572, 50291W, 55645 and two 2102..... |
| 15395 | 21474 | Tension Thread Guard..... |
| 26075 | 21471 | Thread Cutter and Holder..... |
| 15272 | 21471 | " Take-up Cam with 1293C..... |
| 15434 | ----- | " " " 15272 with 570C and 1520R..... |
| 1293C | 21471 | Thread Take-up Cam Position Screw..... |
| 15492 | 21471 | " " Lever with 1822 and 50527C..... |
| 50527C | 21471 | Thread Take-up Lever Hinge Screw..... |
| 1822 | 21471 | " " " Roller and Stud.... |
| 55645 | 21474 | " " Spring..... |
| 15412 | 21474 | " " " Regulator..... |
| 857B | 21474 | " " " " Set Screw |
| 15316 | ----- | Throat Plate, large needle hole, for 15279..... |
| 15280 | 21474 | Throat Plate, medium needle hole, for 15279..... |
| 15317 | ----- | Throat Plate, small needle hole, for 15279..... |
| Note: Throat Plate No. 15280 is regularly furnished with this machine. | | |
| 691A | 21474 | Throat Plate Screw (2)..... |
| *15404 | ----- | Trade Mark..... |
| 15405 | ----- | " " Rivet (2)..... |

From the Library of the University of Toronto

MACHINE No. 15-97

FOR FAMILY USE. C. B. SHUTTLE. DROP FEED.
BALANCED MACHINE.

NOTE: THIS MACHINE IS THE NO. 15-96 MACHINE WITH A
B. R. MOTOR. MOULDED SINGERLIGHT AND THE
FOLLOWING EXCEPTION:

| No. | Plate | Name |
|-------|-------|--|
| 32672 | 21471 | Balance Wheel, 3 1/4 in. pulley, in place of 15282..... |

**Genuine Singer Needles should be used
in Singer Machines.
These Needles and their Containers
are marked with the
Company's Trade Mark "SIMANCO." 1**

**Needles in Containers marked
"For Singer Machines"
are not Singer made needles. 2**

MACHINE No. 15-98

FOR FAMILY USE. C. B. SHUTTLE. DROP FEED.
BALANCED MACHINE. HAND ATTACHMENT.

NOTE: THIS MACHINE IS THE NO. 15-96 MACHINE
WITH A HAND ATTACHMENT.

HAND ATTACHMENT PARTS

| No. | Plate | Name |
|--------|-------|--|
| 94050 | 21476 | Body..... |
| 94027 | 21476 | " Bracket..... |
| 183E | 21476 | " " Screw (2)..... |
| 94028 | 21476 | Crank Handle (wood)..... |
| 94029 | 21476 | " " Spindle..... |
| 94030 | 21476 | " " " Flange (loose).... |
| 94069 | 21476 | " Hinge Pin..... |
| 94031 | 21476 | " Lever..... |
| 94032 | 21476 | " " Lock Pin..... |
| 94033 | 21476 | " " " " Head..... |
| 8282 | 21476 | " " " " Spring..... |
| 94034 | ---- | Crank complete, Nos. 94028 to 94031.... |
| 94046 | 21476 | Driver..... |
| 94036 | 21476 | " Finger..... |
| 94041 | ---- | " " 94036 with SS567E, 94039 and 94040..... |
| 94039 | 21476 | Driver Finger Driving Pad (rawhide).... |
| 94040 | 21476 | " " " " Plate..... |
| SS567E | 21476 | " " " " and Plate Screw..... |
| 94044 | 21476 | Driver Finger Hinge Pin..... |
| 94037 | 21476 | " " Latch..... |
| SS565E | 21476 | " " " Screw Stud..... |
| 94038 | 21476 | " " " Spring..... |
| 94051 | 21476 | Gear with 8282, 94032 and 94033..... |
| 94016 | 21476 | " Cover..... |
| 399A | 21476 | " " Screw (2)..... |
| SS599F | 21476 | " Screw Stud..... |
| 94048 | 21476 | Pinion..... |
| SS600F | 21476 | " Screw Stud..... |
| 80028 | 21476 | " Dowel Pin..... |
| 94052 | 21476 | Hand Attachment complete, Nos. SS565E, SS566C, SS599F, SS600F, 80028, 94016, 94027, 94034, 94037, 94038, 94041, 94044, 94046, 94048, 94050, 94051, 94069 and two each 183E and 399A..... |
| SS566C | 21476 | Hand Attachment Screw..... |

From the Library of Diamond Needle Corp.

MOTOR PARTS

| No. | Plate | Name | No. | Plate | Name |
|--------|-------|---|---------|-------|---|
| | | | 193455 | ----- | Field Coil complete for B.R. 9 Motor.... |
| | | | 193458 | ----- | Field Coil complete for B.R. 10 and B.R. 11 Motors..... |
| 193476 | ----- | Armature complete for B.R. 3 Motor..... | 193461 | ----- | Field Coil complete for B.R. 12 Motor... |
| 193477 | ----- | Armature complete for B.R. 5 Motor..... | 193464 | ----- | Field Coil complete for B.R. 15 Motor... |
| 193318 | 20207 | Armature complete for B.R. 6 and B.R. 7 Motors..... | 193467 | ----- | Field Coil complete for B.R. 87 Motor... |
| 193478 | ----- | Armature complete for B.R. 8 Motor..... | 193470 | ----- | Field Coil complete for B.R. 90 Motor... |
| 193479 | ----- | Armature complete for B.R. 9 Motor..... | 193473 | ----- | Field Coil complete for B.R. 92 Motor... |
| 193480 | ----- | Armature complete for B.R. 10 and B.R. 92 Motors..... | 190563 | ----- | " " Retainer..... |
| 193481 | ----- | Armature complete for B.R. 11 and B.R. 12 Motors..... | 192240 | ----- | " " Tube (paper)..... |
| 193482 | ----- | Armature complete for B.R. 15 Motor.... | 193241 | 20207 | Field Core complete..... |
| 193483 | ----- | Armature complete for B.R. 87 Motor.... | 193242 | 20207 | " " Insulation..... |
| 193484 | ----- | Armature complete for B.R. 90 Motor.... | 194967 | ----- | " " Shield (moulded) for B.R. 7 Motor..... |
| 193230 | 20207 | " Shaft Bearing Sleeve Cap (commutator end)..... | 194968 | ----- | Field Core Shield (moulded) for all B.R. Motors except B.R. 7 Motor..... |
| 194494 | 20207 | Armature Shaft Grease Cup Body (2)..... | 192851 | ----- | Lead Cord complete with Three-Pin Terminal (female half) from lamp socket to Three-Pin Terminal, for knee or treadle control..... |
| 194490 | 20207 | " " " " Wick (felt) (2)..... | 192641 | 20207 | Motor Bracket..... |
| 194326 | 20207 | Armature Shaft Grease Cup Wick Spring (2)..... | 50632CR | 20207 | " " Screw..... |
| 191097 | 20207 | Armature Thrust Washer (commutator end) fibre..... | 190058 | 20207 | " " Retaining Washer (fibre)..... |
| 701400 | 20207 | Armature Thrust Washer (pulley end) fibre..... | 191417 | 20207 | Motor Bracket Screw Washer..... |
| 191098 | 20207 | Armature Thrust Washer (pulley end) (peerless paper)..... | 193287 | 20207 | Motor Bracket complete, Nos. 50632CR, 51208E, 190058, 191417, 192641 and 701513..... |
| 193066 | 20207 | Belt (moulded) for Spoked Balance Wheel No. 15282..... | 51208E | 20207 | Motor Screw..... |
| 193077 | ----- | Belt (moulded) for Disc Balance Wheel No. 32672..... | 701513 | 20207 | " " Retaining Washer (fibre)... |
| 190782 | 20207 | Brush (carbon) for 32 to 145 volts (2).. | 193231 | 20207 | Pulley (moulded)..... |
| 192947 | ----- | " " " 150 to 250 volts (2).. | 51207C | 20207 | " Position Screw..... |
| 193229 | 20207 | " Cap (2)..... | 51093R | 21378 | Three-Pin Terminal (female half) Housing Screw (2)..... |
| 192083 | 20207 | " Spring (2)..... | 1768R | 21378 | Three-Pin Terminal (female half) Housing Screw Nut (2)..... |
| 193228 | 20207 | " Tube (2)..... | 192692 | ----- | Three-Pin Terminal (female half) Insert Clamp (3)..... |
| 193238 | 20207 | " " Terminal (2)..... | 194533 | ----- | Three-Pin Terminal (female half) complete for 192851, Nos. two each 1768R, 51093R and three 192692..... |
| 190059 | 20207 | Commutator complete..... | 51582 | 20207 | Three-Pin Terminal Body (male half) Post Thumb Nut (3)..... |
| 194295 | 20207 | End Covers complete, Nos. two each 194326, 194490 and 194494..... | 701719 | 20207 | Three-Pin Terminal Body (male half) Post Washer (3)..... |
| 51206R | 20207 | End Cover Screw (2)..... | 192797 | 20207 | Three-Pin Terminal Body (male half) complete, Nos. three each 51582 and 701719..... |
| 193236 | 20207 | Fan..... | 145R | 20207 | Three-Pin Terminal Body (male half) Screw..... |
| 193440 | ----- | Field Coil complete for B.R. 3 Motor... | 190613 | 20207 | Tube filled with Singer Motor Lubricant (packed in carton)..... |
| 193443 | ----- | Field Coil complete for B.R. 5 Motor.... | | | |
| 193446 | ----- | Field Coil complete for B.R. 6 Motor.... | | | |
| 193449 | 20207 | Field Coil complete for B.R. 7 Motor.... | | | |
| 193452 | ----- | Field Coil complete for B.R. 8 Motor.... | | | |

FOOT CONTROLLERS (Bakelite)

| No. | Plate | Name |
|---------|-------|--|
| 194583 | ----- | Controller complete, for 32 to 55 volts, A.C. or D.C. Motor, Nos. 194321, 194569, 194573, 194574, 899287, two 964317 and four each 140099R and 194407..... |
| 194584 | 21378 | Controller complete, for 95 to 145 volts, A.C. or D.C. Motor, Nos. 194321, 194570, 194573, 194574, 899815, two 964317 and four each 140099R and 194407..... |
| 194585 | ----- | Controller complete, for 150 to 250 volts, A.C. or D.C. Motor, Nos. 194321, 194571, 194573, 194574, 899287, two 964317 and four each 140099R and 194407..... |
| 194572 | 20210 | Controller Base..... |
| 194569 | ----- | " " 194572 with 192211, 194418, 194774, 194775 and two each 23258, 140100R, 140103R, 194404, 194514 and 931090, for 194583..... |
| 194570 | ----- | Controller Base 194572 with 192140, 194418, 194774, 194775 and two each 23258, 140100R, 140103R, 194404, 194514 and 931090, for 194584..... |
| 194571 | ----- | Controller Base 194572 with 192141, 194418, 194774, 194775 and two each 23258, 140100R, 140103R, 194404, 194514 and 931090, for 194585..... |
| 194407 | 21378 | Controller Base Cushion (rubber) (4).... |
| 140099R | 21378 | " " Screw (4)..... |
| 194573 | 21378 | " Cover..... |
| 194321 | 21378 | " Foot Pedal..... |
| 194574 | 21378 | Controller Lead Cord complete with Three-Pin Terminal (female half) from lamp socket to Three-Pin Terminal and controller..... |
| 192211 | ----- | Controller Resistance Unit, for 32 to 55 volts..... |
| 192140 | 21378 | Controller Resistance Unit, for 95 to 145 volts..... |
| 192141 | ----- | Controller Resistance Unit, for 150 to 250 volts..... |
| 194774 | 21378 | Controller Resistance Unit Adjusting Nut |
| 194775 | 21378 | " " " " " " |
| | | Lock Spring..... |
| 194416 | 21378 | Controller Resistance Unit Bell Crank... |

| No. | Plate | Name |
|---------|-------|---|
| 51340C | 21378 | Controller Resistance Unit Bell Crank Hinge Screw..... |
| 1607J | 21378 | Controller Resistance Unit Bell Crank Hinge Screw Nut..... |
| 194404 | 21378 | Controller Resistance Unit Bell Crank Spring (2)..... |
| 194402 | 21378 | Controller Resistance Unit Bell Crank Spring Bracket..... |
| 194418 | ----- | Controller Resistance Unit Bell Crank Spring Bracket 194402 with 194416, 194773 and two each 1607J and 51340C |
| 140100R | ----- | Controller Resistance Unit Bell Crank Spring Bracket Screw (2)..... |
| 194514 | ----- | Controller Resistance Unit Bell Crank Spring Bracket Screw Insulating Disc (2)..... |
| 140103R | 21378 | Controller Resistance Unit Screw (2).... |
| 931090 | ----- | " " " " Washer (asbestos) (2)..... |
| 23258 | 21378 | Controller Resistance Unit Screw Washer (steel) (2)..... |
| 193384 | 21378 | Controller Resistance Unit Short Circuiting Contact..... |
| 51327J | 21378 | Controller Resistance Unit Short Circuiting Contact Screw..... |
| 194773 | 21378 | Controller Resistance Unit Yoke..... |
| 51340C | 21378 | " " " " Hinge Screw..... |
| 1607J | 21378 | Controller Resistance Unit Yoke Hinge Screw Nut..... |
| *899815 | ----- | Name Plate for 194584..... |
| *899287 | ----- | " " " 194583 and 194585..... |
| 964317 | ----- | " " Drive Screw (2)..... |
| 51093R | 21378 | Three-Pin Terminal (female half) Housing Screw (2)..... |
| 1768R | 21378 | Three-Pin Terminal (female half) Housing Screw Nut (2)..... |
| 192692 | ----- | Three-Pin Terminal (female half) Insert Clamp (3)..... |
| 194521 | 21378 | Three-Pin Terminal (female half) complete for 194574, Nos. two each 1768R, 51093R and three 192692..... |

CONTROLLERS (Bakelite)
CONVERTIBLE FOR FOOT OR KNEE CONTROL
 FOR SETS Nos. 40, 47, 50, 56, 401 AND 402

| No. | Plate | Name |
|---------|-------|--|
| 194587 | ----- | Controller complete, for 32 to 55 volts, A.C. or D.C. Motor, Nos. 194321, 194569, 194573, 194579, 899287, two 964317 and four each 140099R and 194407..... |
| 194588 | 20210 | Controller complete, for 95 to 145 volts, A.C. or D.C. Motor, Nos. 194321, 194570, 194573, 194579, 899816, two 964317 and four each 140099R and 194407..... |
| 194589 | ----- | Controller complete, for 150 to 250 volts, A.C. or D.C. Motor, Nos. 194321, 194571, 194573, 194579, 899287, two 964317 and four each 140099R and 194407..... |
| 194572 | 20210 | Controller Base..... |
| 194569 | ----- | " " 194572 with 192211, 194418, 194774, 194775 and two each 23258, 140100R, 140103R, 194404, 194514 and 931090, for 194587..... |
| 194570 | ----- | Controller Base 194572 with 192140, 194418, 194774, 194775 and two each 23258, 140100R, 140103R, 194404, 194514 and 931090, for 194588..... |
| 194571 | ----- | Controller Base 194572 with 192141, 194418, 194774, 194775 and two each 23258, 140100R, 140103R, 194404, 194514 and 931090, for 194589..... |
| 194407 | 20210 | Controller Base Cushion (rubber) (4).... |
| 140099R | 20210 | " " Screw (4)..... |
| 194573 | 20210 | " Cover..... |
| 194321 | 20210 | " Foot Pedal..... |
| 194579 | 20210 | Controller Lead complete..... |
| 192211 | ----- | " Resistance Unit, for 32 to 55 volts..... |
| 192140 | 20210 | Controller Resistance Unit, for 95 to 145 volts..... |
| 192141 | ----- | Controller Resistance Unit, for 150 to 250 volts..... |
| 194774 | 20210 | Controller Resistance Unit Adjusting Nut |
| 194775 | 20210 | " " " " " " |
| | | Lock Spring..... |
| 194416 | 20210 | Controller Resistance Unit Bell Crank... |

| No. | Plate | Name |
|---------|-------|---|
| 51340C | 20210 | Controller Resistance Unit Bell Crank Hinge Screw..... |
| 1607J | 20210 | Controller Resistance Unit Bell Crank Hinge Screw Nut (2)..... |
| 194404 | 20210 | Controller Resistance Unit Bell Crank Spring (2)..... |
| 194402 | 20210 | Controller Resistance Unit Bell Crank Spring Bracket..... |
| 194418 | ----- | Controller Resistance Unit Bell Crank Spring Bracket 194402 with 194416, 194773 and two each 1607J and 51340C |
| 140100R | ----- | Controller Resistance Unit Bell Crank Spring Bracket Screw (2)..... |
| 194514 | ----- | Controller Resistance Unit Bell Crank Spring Bracket Screw Insulating Disc (2)..... |
| 140103R | 20210 | Controller Resistance Unit Screw (2).... |
| 931090 | ----- | " " " " Washer (asbestos) (2)..... |
| 23258 | 20210 | Controller Resistance Unit Screw Washer (steel) (2)..... |
| 193384 | 20210 | Controller Resistance Unit Short Circuiting Contact..... |
| 51327J | 20210 | Controller Resistance Unit Short Circuiting Contact Screw..... |
| 194773 | 20210 | Controller Resistance Unit Yoke..... |
| 51340C | 20210 | " " " " Hinge Screw..... |
| 1607J | 20210 | Controller Resistance Unit Yoke Hinge Screw Nut..... |
| *899816 | ----- | Name Plate for 194588..... |
| *899287 | ----- | " " " 194587 and 194589..... |
| 964317 | ----- | " " Drive Screw (2)..... |

CONTROLLER HOLDER

| No. | Plate | Name |
|--------|-------|---|
| 136136 | 20211 | Controller Holder with four wood screws 3/8 in. No. 4 R.H.M.F., for Bakelite Controllers Nos. 194587 to 194589... |

From the library of National Archives

ELECTRICAL TRIMMINGS

| No. | Plate | Name |
|--------|-------|--|
| 192142 | 20211 | Controller Lead Bushing, for Machine Lifting Plate..... |
| 192143 | 20211 | Controller Lead Bushing Retaining Spring for 192142..... |
| 194546 | 20211 | Controller Lead Tube..... |
| 192918 | 20211 | " " " Clamp..... |

KNEE LEVER PARTS

FOR SETS Nos. 40, 47, 50, 56, 401 and 402

| No. | Plate | Name |
|----------|-------|--|
| 194437 | 20211 | Knee Lever..... |
| 194436 | ----- | " " 194437 with 1611TM, 140107TM, 194438, 194470 and 194545..... |
| 194549 | 20211 | Knee Lever Connecting Link..... |
| 140105TM | 20211 | " " " " Hinge Screw.. |
| 1550TM | 20211 | " " " " " " " " Nut..... |
| 194438 | 20211 | Knee Lever Extension..... |
| 194550 | 20211 | " " " " Hinged Bracket.... |
| 194551 | 20211 | " " " " " " " " Frame |
| 194431 | ----- | " " " " " " " " 194551 with 1550TM, 1708J, 140105TM, 140106J, 194434, 194549 and 194550.. |
| 140106J | 20211 | Knee Lever Extension Hinged Bracket Hinge Screw..... |
| 1708J | 20211 | Knee Lever Extension Hinged Bracket Hinge Screw Nut..... |
| 194434 | 20211 | Knee Lever Extension Hinged Bracket Spring..... |
| 51224TM | 20211 | Knee Lever Extension Thumb Screw..... |
| 5480 | 20211 | " " " " " " " " Friction Washer..... |
| 140107TM | 20211 | Knee Lever Hinge Screw..... |
| 194545 | 20211 | " " " " " " " " Friction Washer.. |
| 1611TM | 20211 | " " " " " " " " Nut..... |
| 194470 | 20211 | " " " " " " " " Washer..... |
| 194430 | 20211 | Knee Lever with Controller Operating Unit complete, Nos. 5480, 51224TM, 194431, 194436 and four wood screws 5/8 in. No. 6 R.H..... |

TREADLE CONTROLLERS (Bakelite)

FOR STANDS Nos. 25281, 25282 and 25294

| No. | Plate | Name |
|---------|-------|--|
| 194384 | ----- | Controller complete, for 32 to 55 volts, A.C. or D.C. Motor, Nos. 194426, 194455, 194491 and two 140102R..... |
| 194385 | 20212 | Controller complete, for 95 to 145 volts, A.C. or D.C. Motor, Nos. 194454, 194455, 194492 and two 140102R |
| 194386 | ----- | Controller complete, for 150 to 250 volts, A.C. or D.C. Motor, Nos. 194426, 194455, 194493 and two 140102R |
| 194322 | 20212 | Controller Base..... |
| 194491 | ----- | " " 194322 with 23258, 192211, 193908, 194422, 194479, 194774, 194775 and two each 140100R, 140103R, 194421, 194514 and 931090, for 194384..... |
| 194492 | ----- | Controller Base 194322 with 23258, 192140, 193908, 194422, 194479, 194774, 194775 and two each 140100R, 140103R, 194421, 194514 and 931090, for 194385 |
| 194493 | ----- | Controller Base 194322 with 23258, 192141, 193908, 194422, 194479, 194774, 194775 and two each 140100R, 140103R, 194421, 194514 and 931090, for 194386 |
| 198001 | 20213 | Controller Bracket for Cabinet Tables... |
| 198002 | 20213 | " " " " Cover Sets..... |
| 51119J | 20213 | " " " " Screw (2)..... |
| 194323 | ----- | " " " " Cover..... |
| 194454 | 20212 | " " " " 194323 with 899691 and two 964317, for 194385..... |
| 194426 | ----- | Controller Cover 194323 with 899287 and two 964317, for 194384 and 194386... |
| 140102R | 20212 | Controller Cover Screw (2)..... |
| 194455 | 20212 | Controller Lead complete..... |
| 193908 | 20212 | " " " " Clamp..... |
| 194479 | 20212 | " " " " " " " " Insulation..... |
| 192866 | 20213 | " " " " Pitman Rod Connection..... |
| 192211 | ----- | " " " " Resistance Unit for 32 to 55 volts..... |
| 192140 | 20212 | Controller Resistance Unit for 95 to 145 volts..... |
| 192141 | ----- | Controller Resistance Unit for 150 to 250 volts..... |
| 194774 | 20212 | Controller Resistance Unit Adjusting Nut |
| 194775 | 20212 | " " " " " " " " Lock Spring..... |

TREADLE CONTROLLERS

| No. | Plate | Name |
|---------|-------|---|
| 194416 | 20212 | Controller Resistance Unit Bell Crank... |
| 194324 | 20212 | " " " " " |
| | | Connecting Link..... |
| 140101C | 20212 | Controller Resistance Unit Bell Crank |
| | | Connecting Link Hinge Screw..... |
| 1607J | 20212 | Controller Resistance Unit Bell Crank |
| | | Connecting Link Hinge Screw Nut..... |
| 51340C | 20212 | Controller Resistance Unit Bell Crank |
| | | Hinge Screw..... |
| 1607J | 20212 | Controller Resistance Unit Bell Crank |
| | | Hinge Screw Nut (2)..... |
| 194421 | 20212 | Controller Resistance Unit Bell Crank |
| | | Spring (2)..... |
| 194402 | 20212 | Controller Resistance Unit Bell Crank |
| | | Spring Bracket..... |
| 194422 | ----- | Controller Resistance Unit Bell Crank |
| | | Spring Bracket 194402 with 51340C, |
| | | 140101C, 194324, 194416, 194773 and two |
| | | 1607J..... |
| 140100R | ----- | Controller Resistance Unit Bell Crank |
| | | Spring Bracket Screw (2)..... |
| 194514 | ----- | Controller Resistance Unit Bell Crank |
| | | Spring Bracket Screw Insulating Disc |
| | | (2)..... |
| 140103R | 20212 | Controller Resistance Unit Screw (2).... |
| 931090 | ----- | " " " " Washer |
| | | (asbestos) (2)..... |
| 23258 | 20212 | Controller Resistance Unit Screw Washer |
| | | (steel)..... |
| 193384 | 20212 | Controller Resistance Unit Short Circuit- |
| | | ing Contact..... |
| 51327J | 20212 | Controller Resistance Unit Short Circuit- |
| | | ing Contact Screw..... |
| 194773 | 20212 | Controller Resistance Unit Yoke..... |
| *899691 | ----- | Name Plate for 194454..... |
| *899287 | ----- | " " " 194426..... |
| 964317 | ----- | " " Drive Screw (2)..... |

TREADLE CONTROLLERS (Bakelite)

FOR STANDS Nos. 46909, 46912 and 46913

| No. | Plate | Name |
|--------|-------|---|
| 194381 | ----- | Controller complete, for 32 to 55 volts, |
| | | A.C. or D.C. Motor, Nos. 194423, |
| | | 194426, 194491 and two 140102R..... |
| 194382 | 20214 | Controller complete, for 95 to 145 volts, |
| | | A.C. or D.C. Motor, Nos. 194423, |
| | | 194425, 194492 and two 140102R..... |

TREADLE CONTROLLERS

| No. | Plate | Name |
|---------|-------|--|
| 194383 | ----- | Controller complete, for 150 to 250 |
| | | volts, A.C. or D.C. Motor, Nos. |
| | | 194423, 194426, 194493 and two 140102R |
| 194322 | 20214 | Controller Base..... |
| 194491 | ----- | " 194322 with 23258, 192211, |
| | | 193908, 194422, 194479, 194774, 194775, |
| | | two each 140100R, 140103R, 194421, |
| | | 194514 and 931090..... |
| 194492 | ----- | Controller Base 194322 with 23258, |
| | | 192140, 193908, 194422, 194479, 194774, |
| | | 194775, two each 140100R, 140103R, |
| | | 194421, 194514 and 931090..... |
| 194493 | ----- | Controller Base 194322 with 23258, |
| | | 192141, 193908, 194422, 194479, 194774, |
| | | 194775, two each 140100R, 140103R, |
| | | 194421, 194514 and 931090..... |
| 198162 | 20215 | Controller Bracket for 198164..... |
| 194399 | ----- | " " " 194468..... |
| 198164 | 20215 | " " 198162 with 198163 and |
| | | three 51119R, for Stands Nos. 46909 |
| | | and 46912..... |
| 194468 | 20215 | Controller Bracket 194399 with 126R and |
| | | 1549R, for Stand No. 46913..... |
| 198163 | 20215 | Controller Bracket Clamp for 198164.... |
| 51119R | 20215 | " " " Screw for 198164 |
| | | (3)..... |
| 126R | 20215 | Controller Bracket Screw for 194468.... |
| 1549R | 20215 | " " " Nut for 194468. |
| 194323 | ----- | " Cover..... |
| 194425 | 20214 | " " 194323 with 899688 and |
| | | two 964317, for 194382..... |
| 194426 | ----- | Controller Cover 194323 with 899287 and |
| | | two 964317, for 194381 and 194383... |
| 140102R | 20214 | Controller Cover Screw (2)..... |
| 194423 | 20214 | Controller Lead complete, from control- |
| | | ler to Three-Pin Terminal..... |
| 193908 | 20214 | Controller Lead Clamp..... |
| 194479 | 20214 | " " " Insulation..... |
| 198169 | 20215 | " Pitman Rod Connection for Stands |
| | | Nos. 46909 and 46912..... |
| 193828 | 20215 | Controller Pitman Rod Connection for |
| | | Stand No. 46913..... |
| 192211 | ----- | Controller Resistance Unit for 32 to 55 |
| | | volts..... |
| 192140 | 20214 | Controller Resistance Unit for 95 to 145 |
| | | volts..... |
| 192141 | ----- | Controller Resistance Unit for 150 to |
| | | 250 volts..... |
| 194774 | 20214 | Controller Resistance Unit Adjusting Nut |
| 194775 | 20214 | " " " " " |
| | | Lock Spring..... |

| No. | Plate | Name |
|---------|-------|--|
| 194416 | 20214 | Controller Resistance Unit Bell Crank... |
| 194324 | 20214 | " " " " " Con- necting Link..... |
| 140101C | 20214 | Controller Resistance Unit Bell Crank Connecting Link Hinge Screw..... |
| 1607J | 20214 | Controller Resistance Unit Bell Crank Connecting Link Hinge Screw Nut..... |
| 51340C | 20214 | Controller Resistance Unit Bell Crank Hinge Screw..... |
| 1607J | 20214 | Controller Resistance Unit Bell Crank Hinge Screw Nut (2)..... |
| 194421 | 20214 | Controller Resistance Unit Bell Crank Spring (2)..... |
| 194402 | 20214 | Controller Resistance Unit Bell Crank Spring Bracket..... |
| 194422 | ----- | Controller Resistance Unit Bell Crank Spring Bracket 194402 with 51340C, 140101C, 194324, 194416, 194773 and two 1607J..... |
| 140100R | ----- | Controller Resistance Unit Bell Crank Spring Bracket Screw (2)..... |
| 194514 | ----- | Controller Resistance Unit Bell Crank Spring Bracket Screw Insulating Disc (2)..... |
| 140103R | 20214 | Controller Resistance Unit Screw (2).... |
| 931090 | ----- | " " " " Washer (asbestos) (2)..... |
| 23258 | 20214 | Controller Resistance Unit Screw Washer (steel)..... |
| 193384 | 20214 | Controller Resistance Unit Short Circuit- ing Contact..... |
| 51327J | 20214 | Controller Resistance Unit Short Circuit- ing Contact Screw..... |
| 194773 | 20214 | Controller Resistance Unit Yoke..... |
| 792R | 20215 | " Screw..... |
| *899688 | ----- | Name Plate for 194425..... |
| *899287 | ----- | " " " 194426..... |
| 964317 | ----- | " " Drive Screw (2)..... |

ELECTRICAL TRIMMINGS

| No. | Plate | Name |
|--------|-------|--|
| 192142 | 20215 | Controller Lead Bushing (for Machine Lifting Plate) for Stand No. 46913.. |
| 192143 | 20215 | Controller Lead Bushing Retaining Spring for 192142, for Stand No. 46913..... |
| 192912 | 20215 | Controller Lead Tube for Stands Nos. 46909 and 46912..... |
| 192912 | 20215 | Controller Lead Tube (long) for Stand No. 46913..... |
| 192918 | 20215 | Controller Lead Tube Clamp..... |

SINGERLIGHTS

SINGERLIGHT No. 193294
FOR THREE-PIN TERMINAL

FOR USE WHEN ARM IS SLOTTED FOR SINGERLIGHT BRACKET

| No. | Plate | Name |
|---------|-------|--|
| *193495 | ----- | Singerlight Bracket..... |
| 193941 | 21480 | " " 193495 with 193942.. |
| *193254 | ----- | " Lamp Contact Lead Terminal for 194594..... |
| *193633 | ----- | Singerlight Lamp Contact Lead Terminal for 193634..... |
| *193278 | ----- | Singerlight Lamp Contact Lead Terminal Plate for 193634..... |
| *193634 | ----- | Singerlight Lamp Contact Lead Terminal Plate 193278 with 193633, for 194607 |
| 51203 | 21480 | Singerlight Lamp Contact Lead Terminal Screw (brass) for 194594 and 194607. |
| *193253 | ----- | Singerlight Lamp Contact Plunger..... |
| *193251 | ----- | " " " " Bushing |
| *193252 | ----- | " " " " Spring (2)..... |
| 193829 | 21480 | Singerlight Lead Strain Relief Disc for 194592..... |
| 50566 | 21480 | Singerlight Lead Terminal Screw (brass) for 194592 (2)..... |
| 51290 | ----- | Singerlight Lead Terminal Screw (brass) for 194605..... |
| 193289 | 21480 | Singerlight Lead complete..... |
| 193240 | ----- | Singerlight Lead complete for Switzer- land..... |
| 198122 | ----- | Singerlight Lead complete for Denmark... |
| 425001 | ----- | Singerlight Lead complete for V.D.E.... |
| 193131 | ----- | Singerlight Lead complete for Australia. |
| 193940 | 21480 | " Nipple for 194305..... |
| 193939 | ----- | " " 194306..... |
| *193937 | ----- | " " Cap with 193938..... |
| 193936 | 21480 | " " 193937 with 50564J..... |
| *193938 | ----- | Singerlight Nipple Cap Insert..... |
| 50564J | 21480 | " " " Set Screw..... |
| 193512 | 21480 | " " Insulating Collar.... |
| 51602R | 21480 | " " Nut..... |
| 701909 | 21480 | " " " Insulating Washer (fibre)..... |
| 193509 | 21480 | Singerlight Nipple Washer (felt) (2)... |
| 193272 | 21480 | " Shade..... |
| 193421 | 21480 | " " 193272 with 193401.... |

| No. | Plate | Name |
|---------|-------|---|
| 193437 | 21480 | Singerlight Shade Friction Washer..... |
| *193267 | ----- | " " Position Pin (2)..... |
| 193401 | 21480 | " " Reflector..... |
| *194596 | ----- | " Socket Body with 193255 and two 193251..... |
| 194594 | 21480 | Singerlight Socket Body 194596 with 51399K, 193254, 193256 to 193258, 194659 and two each 51203, 193252, 193253 and 193267, for 194593..... |
| 194607 | ----- | Singerlight Socket Body 194596 with 51399K, 193257, 193258, 193634, 193635, 194659 and two each 51203, 193252, 193253 and 193267, for 194606 |
| *194593 | ----- | Singerlight Socket Body 194594 with 194305, for 194592..... |
| *194606 | ----- | Singerlight Socket Body 194607 with 194306, for 194605..... |
| 194592 | ----- | Singerlight Socket and Switch complete, Nos. 193829, 193936, 194593, two 50566 and three 51385CR..... |
| 194605 | ----- | Singerlight Socket and Switch complete (V.D.E. Type) Nos. 193271, 193936, 194606, two 51290 and three 51385CR. |
| *193942 | ----- | Singerlight Steady Pin..... |
| *193259 | ----- | " Toggle Switch Contact..... |
| *193271 | ----- | " " Flash Disc for 194605..... |
| *194660 | ----- | Singerlight Toggle Switch Frame..... |
| 51399K | 21480 | " " " " Screw... |
| 194599 | 21480 | " " " Operating Lever |
| *194661 | ----- | " " " " " " |
| | | Hinge Pin..... |
| 194659 | 21480 | Singerlight Toggle Switch complete, Nos. 193259, 193387, 193765, 194599, 194660, 194661 and 194695..... |
| *194304 | 21480 | Singerlight Toggle Switch Shell..... |
| *194305 | ----- | " " " " 194304 with 51602R, 193512 and 193940, for 194593..... |
| *194306 | ----- | Singerlight Toggle Switch Shell 194304 with 51602R, 193512 and 193939, for 194606..... |
| 51385CR | 21480 | Singerlight Toggle Switch Shell Screw... |
| *193258 | ----- | " " " Spring Contact (left)..... |
| *193257 | ----- | Singerlight Toggle Switch Spring Contact (right)..... |
| 51203 | 21480 | Singerlight Toggle Switch Spring Contact (right) Screw (brass)..... |
| *193256 | ----- | Singerlight Toggle Switch Spring Contact Lead Terminal for 194594..... |

| No. | Plate | Name |
|---------------|-------|--|
| *193633 | ----- | Singerlight Toggle Switch Spring Contact Lead Terminal for 193635..... |
| *193276 | ----- | Singerlight Toggle Switch Spring Contact Lead Terminal Plate for 193635..... |
| *193635 | ----- | Singerlight Toggle Switch Spring Contact Lead Terminal Plate 193276 with 193633, for 194607..... |
| *193255 | ----- | Singerlight Toggle Switch Spring Contact Lead Terminal Stud..... |
| *193387 | ----- | Singerlight Toggle Switch Toggle Lever.. |
| *194695 | ----- | " " " " " " |
| | | Spring..... |
| *193765 | ----- | Singerlight Toggle Switch Toggle Lever Spring Washer..... |
| 193294 | 21480 | Singerlight (moulded, less lamp) com- plete, Nos. 691J, 97359, 193289, 193421, 193437, 193941, 194592, 701909 and two 193509..... |
| 193294 | ----- | Singerlight (moulded, less lamp) com- plete, Nos. 691J, 97359, 193421, 193437, 193941, 194605, 198240, 701909 and two 193509..... |
| (Switzerland) | | |
| 193294 | ----- | Singerlight (moulded, less lamp) com- plete, Nos. 691J, 97359, 193421, 193437, 193941, 194605, 198122, 701909 and two 193509..... |
| (Denmark) | | |
| 193294 | ----- | Singerlight (moulded, less lamp) com- plete, Nos. 691J, 97359, 193421, 193437, 193941, 194605, 425001, 701909 and two 193509..... |
| (V.D.E.) | | |
| 193294 | ----- | Singerlight (moulded, less lamp) com- plete, Nos. 691J, 97359, 193421, 193437, 193941, 194592, 198131, 701909 and two 193509..... |
| (Australia) | | |
| 691J | 21480 | Singerlight Screw..... |
| 97359 | 21480 | " " Retaining Washer (fibre)..... |

From the Copyright Clearance Center

SINGERLIGHT No. 193518

FOR USE WHEN ARM IS SLOTTED FOR SINGERLIGHT BRACKET

THIS SINGERLIGHT IS THE SAME AS 193294 WITH THE

FOLLOWING EXCEPTIONS:

| No. | Plate | Name |
|-------------------------|-------|---|
| 194022 | 21480 | Singerlight Lead Cord (8 ft. long) and Plug complete, in place of 193289... |
| 198246 | ----- | Singerlight Flexible Lead Cord (8 ft. long) and Plug complete, for Switzerland, in place of 198240..... |
| 198127 | ----- | Singerlight Flexible Lead Cord (8 ft. long) and Plug complete, for Denmark, in place of 198122..... |
| 198119 | ----- | Singerlight Flexible Lead Cord (8 ft. long) and Plug complete, for V.D.E., in place of 425001..... |
| 198318 | ----- | Singerlight Flexible Lead Cord (8 ft. long) and Plug complete, for Australia, in place of 198131..... |
| 193518 | 21480 | Singerlight (moulded, less lamp) complete, Nos. 691J, 97359, 193421, 193437, 193941, 194022, 194592, 701909 and two 193509..... |
| 193518 (Switzerland) | ----- | Singerlight (moulded, less lamp) complete, Nos. 691J, 97359, 193421, 193437, 193941, 194605, 198246, 701909 and two 193509..... |
| 193518 (Denmark) | ----- | Singerlight (moulded, less lamp) complete, Nos. 691J, 97359, 193421, 193437, 193941, 194605, 198127, 701909 and two 193509..... |
| 193518 (V.D.E.) | ----- | Singerlight (moulded, less lamp) complete, Nos. 691J, 97359, 193421, 193437, 193941, 194605, 198119, 701909 and two 193509..... |
| 193518 (Australia) | ----- | Singerlight (moulded, less lamp) complete, Nos. 691J, 97359, 193421, 193437, 193941, 194592, 198318, 701909 and two 193509..... |

SINGERLIGHT LAMP

| No. | Plate | Name |
|--------|-------|-----------------------|
| 194120 | 21480 | Singerlight Lamp..... |

Note: When ordering No. 194120, state voltage required. We are prepared to furnish the following voltages:

| |
|------------|
| 32 |
| 50 |
| 110 to 120 |
| 200 to 220 |
| 230 to 250 |

ACCESSORIES

| No. | Plate | Name |
|--------|-------|--|
| 120862 | 21479 | Oil Can, contents 1 1/3 fl. oz. (filled with household oil)..... |
| 120329 | ----- | Machine Cover..... |

ATTACHMENT SET

| No. | Plate | Name |
|--------|-------|--|
| 8879 | 21477 | Arm Spool Pin Washer (cloth)..... |
| 121461 | 21477 | Binder Folder..... |
| 51104B | 21477 | " " Screw..... |
| 120565 | 21477 | " " Washer..... |
| 121463 | 21477 | " Foot..... |
| 121464 | 21477 | Binder complete, Nos. 51104B, 120565, 121461 and 121463..... |
| 25527 | 21477 | Cloth Guide..... |
| 50053B | 21477 | " " Thumb Screw..... |
| 35931 | 21477 | Hemmer (adjustable)..... |
| 120842 | 21477 | " (foot) flat bottom for 5/64 in. hem..... |
| 25537 | 21477 | Screw Driver (machine)..... |
| 120378 | 21477 | " " (shuttle tension)..... |
| 2518 | 21477 | Shuttle Bobbin (5)..... |
| 36583 | 21477 | Tucker complete..... |
| 120309 | ----- | Attachment Set, Nos. 8879, 25527, 25537, 35931, 36583, 50053B, 120378, 120842, 121464 and five 2518..... |

ATTACHMENT SET

| No. | Plate | Name |
|--------|-------|--|
| 120598 | 21477 | Ruffler for one, six and twelve stitch ruffling..... |
| 120603 | 21477 | Attachment Set complete, Nos. 120309 and 120598..... |

BIAS GAUGE

| No. | Plate | Name |
|-------|-------|-----------------|
| 25525 | 21479 | Bias Gauge..... |

BOBBIN WINDER

FOR BALANCE WHEEL No. 15282 or No. 32672

| No. | Plate | Name |
|----------|-------|--|
| 15072 | 21475 | Bobbin Position Pin..... |
| 125324 | 21475 | Bracket (belt cover)..... |
| 158E | 21475 | " Screw (2)..... |
| 66670 | 21475 | Frame..... |
| 125366 | ----- | " 66670 with 15288 and 125068..... |
| 51319R | 21475 | " Hinge Screw..... |
| 66601 | 21475 | " Spring..... |
| 15287 | 21475 | Friction Ring (rubber)..... |
| 15288 | 21475 | Pulley..... |
| 125068 | 21475 | Spindle with 15072..... |
| 125376 | 21475 | Stop Latch..... |
| 51303R | 21475 | " " Hinge Screw..... |
| 66775 | 21475 | " " Spring..... |
| 125395 | 21475 | Tension Bracket..... |
| 45845 | 21475 | " Disc..... |
| 45847 | 21475 | " " Spring..... |
| 1401382B | 21475 | " Screw..... |
| 45846 | 21475 | " " Washer..... |
| 125396 | 21475 | Tension Bracket complete, Nos. 45845 to 45847, 125395 and 1401382B..... |
| 193B | 21475 | Tension Bracket Screw..... |
| 7071 | 21475 | " " " Washer..... |
| 125326 | 21475 | Tripping Arm..... |
| 190R | 21475 | " " Screw..... |
| 125327 | 21475 | Bobbin Winder complete, Nos. 190R, 15287, 51303R, 51319R, 66601, 66775, 125324, 125326, 125366 and 125376..... |

BRAIDER

| No. | Plate | Name |
|-------|-------|--------------------|
| 25510 | 21478 | Braider..... |
| 289B | 21478 | " Thumb Screw..... |

CORDER (Bow)

FOR TOP CORDING

| No. | Plate | Name |
|-------|-------|--------------------------|
| 26399 | 21479 | Corder Bow complete..... |
| 190J | 21479 | " Screw..... |

FELLER (Foot)

| No. | Plate | Name |
|-------|-------|--------------------|
| 36835 | 21478 | Feller (foot)..... |

FEED COVER PLATE

| No. | Plate | Name |
|-------|-------|-----------------------|
| 15359 | 21479 | Feed Cover Plate..... |

FINGER GUARD

| No. | Plate | Name |
|--------|-------|-------------------|
| 121725 | 21478 | Finger Guard..... |

HEMMER (Foot)

| No. | Plate | Name |
|-------|-------|------------------------------------|
| 25893 | 21478 | Hemmer (foot) for 1/4 in. hem..... |

HEMSTITCHER

| No. | Plate | Name |
|--------|-------|--|
| 120687 | 21478 | Hemstitcher with Yielding Presser Plate. |

PRESSER FOOT WITH GRADUATED
ADJUSTABLE GUIDES

| No. | Plate | Name |
|--------|-------|--|
| 121717 | 21479 | Presser Foot..... |
| 35002 | 21479 | " " Extension..... |
| 35003 | 21479 | Presser Foot Graduated Adjustable Guide (long, left)..... |
| 35004 | 21479 | Presser Foot Graduated Adjustable Guide (long, right)..... |
| 35005 | 21479 | Presser Foot Graduated Adjustable Guide (short, right)..... |
| 35006 | 21479 | Presser Foot Graduated Adjustable Guide (short, right) flush..... |
| 35135 | 21479 | Presser Foot Graduated Adjustable Guide Clamp..... |
| 35206 | 21479 | Presser Foot Graduated Adjustable Guide Clamp Lever..... |
| 337D | 21479 | Presser Foot Graduated Adjustable Guide Clamp Screw..... |
| 121718 | 21479 | Presser Foot with Extension and Gradu- ated Adjustable Guides complete, Nos. 337D, 35002 to 35006, 35135, 35206 and 121717..... |

PRESSER FEET

| No. | Plate | Name |
|--------|-------|--|
| 15429 | 21478 | Presser Foot (needle hole on right hand side) for stitching on edge and in- serting braid..... |
| 125035 | 21478 | Presser Foot (needle hole on left hand side) for stitching on edge and in- serting braid..... |
| 36058 | 21478 | Presser Foot with 665B and 36059, for blind stitch cording, to turn small curves..... |

| No. | Plate | Name |
|--|-------|--|
| 36059 | 21478 | Presser Foot Cord Guide..... |
| Note: When ordering No. 36058 or 36059, send sample of cord for which it is to be used. | | |
| 665B | 21478 | Presser Foot Cord Guide Screw..... |
| 2506 | 21478 | Feed Dog for 2831, for 36058..... |
| 2831 | 21478 | Throat Plate, large needle hole, for 2506..... |
| 36067 | 21478 | Presser Foot, for braiding, for art work, for braid 1/16 in. to 3/16 in. wide..... |
| Note: When ordering No. 36067, state the size or send sample of braid for which it is to be used. | | |
| 25978 | 21478 | Presser Foot (single toe) for gathering. |
| 121441 | 21478 | " " (double toe) for gathering. |

QUILTER

| No. | Plate | Name |
|-------|-------|--------------|
| 35932 | 21478 | Quilter..... |

RUFFLER SHIRRING PLATE
(UNIVERSAL)

| No. | Plate | Name |
|--------|-------|--|
| 121170 | 21479 | Ruffler Shirring Plate (universal) with 51395W..... |
| 51395W | 21479 | Ruffler Shirring Plate Thumb Screw..... |

UNDER BRAIDER

| No. | Plate | Name |
|--------|-------|--------------------|
| 121547 | 21479 | Under Braider..... |
| 25637 | 21479 | " " Foot..... |

SPECIAL ATTACHMENTS

FOR COMPONENT PARTS OF THESE ATTACHMENTS,
REFER TO FORM I9385, LIST OF PARTS FOR SINGER
FASHION AIDS.

| No. | Plate | Name |
|--------|-------|--|
| 121795 | ----- | Buttonhole Attachment complete..... |
| 121094 | ----- | Darning Foot (spring) complete..... |
| 36865 | ----- | Edge Stitcher..... |
| 26538 | ----- | Embroidery Attachment complete for one thread..... |
| 35505 | ----- | Embroidery Attachment complete for two threads..... |
| 121387 | ----- | Hemstitching and Picoting Attachment complete..... |
| 121634 | ----- | Needle Threader and Seam Ripper com- plete..... |
| 121255 | ----- | Singercraft Fagoter complete..... |
| 121079 | ----- | Singercraft Guide complete..... |
| 35985 | ----- | Tubular Trimming Attachment complete.... |
| 121706 | ----- | Zigzag Attachment (adjustable) com- plete..... |

**Genuine Singer Needles should be used
in Singer Machines.
These Needles and their Containers
are marked with the
Company's Trade Mark "SIMANCO" 1**

**Needles in Containers marked
"For Singer Machines"
are not Singer made needles. 2**

NUMERICAL LIST OF PARTS

| No. | Plate | Name |
|--------|-------|--|
| 126R | 20215 | Controller Bracket Screw for 194468..... |
| 138E | 21471 | Arm Screw (2)..... |
| 145J | 21473 | Shuttle Race Screw (2)..... |
| 145R | 20207 | Three-Pin Terminal Body (male half) Screw..... |
| 155C | 21471 | Needle Bar Connecting Stud Set Screw for 2052..... |
| 157J | 21472 | Feed Lifting Rock Shaft Crank Clamping Screw for 2509..... |
| 158E | 21475 | Bobbin Winder Bracket Screw (2)..... |
| 183E | 21476 | Hand Attachment Body Bracket Screw for 94052, for 15-98 Machine (2)..... |
| 190B | 21474 | Face Plate Screw..... |
| 190J | 21479 | Corder Screw..... |
| 190R | 21475 | Bobbin Winder Tripping Arm Screw for 125327..... |
| 193B | 21475 | Bobbin Winder Tension Bracket Screw..... |
| 208E | 21474 | Feed Dog Screw (2)..... |
| 248A | 21471 | Clamp Stop Motion Clamp Stop Screw for 15314..... |
| 251A | 21471 | Needle Bar Thread Guard Screw..... |
| 256B | 21471 | Clamp Stop Motion Clamp Screw for 15314. |
| 289B | 21478 | Braider Thumb Screw..... |
| 307C | 21472 | Feed Lifting Rock Shaft Screw Center for 56814..... |
| 307C | 21472 | Feed Rock Shaft Screw Center for 56814.. |
| 307C | 21472 | Oscillating Rock Shaft Screw Center for 56814..... |
| 337D | 21479 | Presser Foot Graduated Adjustable Guide Clamp Screw for 121718..... |
| 315C | 21472 | Feed Bar Screw Center for 15445..... |
| 375C | 21471 | Crank Connecting Rod Hinge Screw..... |
| 399A | 21476 | Hand Attachment Gear Cover Screw for 94052, for 15-98 Machine (2)..... |
| 435C | 21471 | Arm Shaft Bushing Set Screw for 125106.. |
| 448C | 21471 | Presser Bar Lifter Hinge Stud Set Screw for 125106..... |
| 453C | 21471 | Presser Bar Spring Bracket Set Screw for 2068..... |
| 462C | 21471 | Clamp Stop Motion Flanged Bushing Set Screw for 15313 (2)..... |
| 462C | 21472 | Oscillating Shaft Crank Set Screw for 125059 (2)..... |
| 462C | 21472 | Shuttle Driver Set Screw for 125064 (2).. |
| 552C | 21471 | Needle Clamp Thumb Screw for 2054..... |
| SS565E | 21476 | Hand Attachment Driver Finger Latch Screw Stud for 94052, for 15-98 Ma- chine..... |

| No. | Plate | Name |
|--------|-------|---|
| SS566C | 21476 | Hand Attachment Screw for 94052, for 15-98 Machine..... |
| SS567E | 21476 | Hand Attachment Driver Finger Driving Pad and Plate Screw for 94041, for 15-98 Machine..... |
| 570C | 21471 | Needle Bar Connecting Link Hinge Screw for 15434..... |
| 591F | 21473 | Shuttle Tension Regulating Screw for 15277..... |
| 592E | 21473 | Shuttle Bobbin Case Latch Stop Screw for 15277..... |
| SS599F | 21476 | Hand Attachment Gear Screw Stud for 94052, for 15-98 Machine..... |
| SS600F | 21476 | Hand Attachment Pinion Screw Stud for 94052, for 15-98 Machine..... |
| 648J | 21473 | Shuttle Race Back Spring Screw for 2528. |
| 662J | 21473 | " " Cap Screw for 15420 (2).... |
| 665B | 21478 | Presser Foot Cord Guide Screw for 36058. |
| 691A | 21474 | Throat Plate Screw (2)..... |
| 691J | 21480 | Singerlight Screw for 193294 and 193518. |
| 792R | 20215 | Controller Screw..... |
| 857B | 21474 | Thread Take-up Spring Regulator Set Screw for 15432..... |
| 896C | 21471 | Crank Connecting Rod Cap Screw for 125021..... |
| 1085E | 21471 | Feed Forked Connection Slide Block Screw Stud for 125335..... |
| 1285C | 21471 | Feed Cam and Counterbalance Position Screw for 125045..... |
| 1293C | 21471 | Thread Take-up Cam Position Screw for 15272..... |
| 1381C | 21471 | Feed Forked Connection Hinge Screw (eccentric)..... |
| 1498C | 21471 | Needle Bar Bushing Set Screw..... |
| 1513J | 21472 | Feed Lifting Rock Shaft Screw Center Nut for 56814..... |
| 1513J | 21472 | Feed Rock Shaft Screw Center Nut for 56814..... |
| 1513J | 21472 | Oscillating Rock Shaft Screw Center Nut for 56814..... |
| 1518J | 21471 | Crank Connecting Rod Hinge Screw Nut.... |
| 1519J | 21472 | Feed Bar Screw Center Nut for 15445..... |
| 1520J | 21471 | " Forked Connection Hinge Screw Nut.. |
| 1520R | 21471 | Needle Bar Connecting Link Hinge Screw Nut for 15434..... |
| 1549R | 20215 | Controller Bracket Screw Nut for 194468. |
| 1550TM | 20211 | Knee Lever Connecting Link Hinge Screw Nut for 194431..... |
| 1560B | 21474 | Tension Regulating Thumb Nut for 15471.. |
| 1607J | 20214 | Controller Resistance Unit Bell Crank Connecting Link Hinge Screw Nut for 194422..... |

| No. | Plate | Name |
|--------|-------|--|
| 1607J | 20212 | Controller Resistance Unit Bell Crank Hinge Screw Nut for 194418 and 194422 (2)..... |
| 1607J | 21378 | Controller Resistance Unit Yoke Hinge Screw Nut for 194418..... |
| 1611TM | 20211 | Knee Lever Hinge Screw Nut for 194436... |
| 1708J | 20211 | " " Extension Hinged Bracket Hinge Screw Nut for 194431..... |
| 1768R | 21378 | Three-Pin Terminal (female half) Housing Screw Nut for 194521 and 194533 (2). |
| 1813 | 21472 | Feed Lifting Rock Shaft Crank Roller and Stud for 2509..... |
| 1822 | 21471 | Thread Take-up Lever Roller and Stud for 15492..... |
| 2002 | 21471 | ARM Dowel Pin (2)..... |
| 2007 | 21471 | " Spool Pin..... |
| 2020 | 21471 | Clamp Stop Motion Clamp Washer for 15314 |
| 2052 | 21471 | Needle Bar Connecting Stud with 1550, for 15374..... |
| 2054 | 21471 | Needle Clamp with 5520..... |
| 2068 | 21471 | Presser Bar Spring Bracket with 4530.... |
| 2070 | 21471 | " " " Washer..... |
| 2102 | 21474 | Tension Disc for 15471..... |
| 2506 | 21478 | Feed Dog for 2831 for 36058..... |
| 2509 | 21472 | " Lifting Rock Shaft Crank with 157J and 1813, for 2836..... |
| 2510 | 21472 | Oscillating Shaft..... |
| 2515 | 21473 | Shuttle Body for 125018..... |
| 2518 | 21473 | " Bobbin for 120309 and 125018.... |
| 2528 | 21473 | Shuttle Race complete, Nos. 648J, 2831, 15420, 125080 and two 2532..... |
| 2530 | 21473 | Shuttle Race Body for 15420..... |
| 2531 | 21473 | " " Back for 2528..... |
| 2532 | 21473 | " " " Position Pin for 2528 (2)..... |
| 2535 | 21473 | Shuttle Race Cap for 15420..... |
| 2816 | 21472 | Feed Lifting Rock Shaft for 2836..... |
| 2824 | 21474 | Shuttle Race Slide Spring for 15147.... |
| 2831 | 21478 | Throat Plate, large needle hole, for 2506..... |
| 2835 | 21472 | Feed Bar..... |
| 2836 | ----- | Feed Lifting Rock Shaft complete, Nos. 2509 and 2816..... |
| 2973 | 21473 | Shuttle Bobbin Case Latch Lever for 15141..... |
| 2974 | 21473 | Shuttle Bobbin Case Latch Lever Fulcrum Pin for 15141..... |
| 2975 | 21473 | Shuttle Bobbin Case Latch Spring for 15277 |
| 5480 | 20211 | Knee Lever Extension Thumb Screw Friction Washer for 194430..... |

From the library of Dan and Nancy

NUMERICAL LIST OF PARTS

| No. | Plate | Name |
|--------|-------|--|
| 7071 | 21475 | Bobbin Winder Tension Bracket Screw Washer..... |
| 8217 | 21471 | Feed Regulator Friction Washer..... |
| 8282 | 21476 | Hand Attachment Crank Lever Lock Pin Spring for 94051, for 15-98 Machine. |
| 8879 | 21471 | Arm Spool Pin Washer (cloth) for 120309. |
| 13710 | 21474 | Tension Spring for 15471..... |
| 15072 | 21475 | Bobbin Winder Bobbin Position Pin for 125068..... |
| 15140 | 21473 | Shuttle Bobbin Case Latch for 15141..... |
| 15141 | 21473 | Shuttle Bobbin Case Hinge for 15277, Nos. 2973, 2974 and 15140..... |
| 15147 | 21474 | Shuttle Race Slide complete, Nos. 2824, 15188 and two 51282J..... |
| 15188 | 21474 | Shuttle Race Slide for 15147..... |
| 15238 | 21474 | Tension Releasing Pin for 15471..... |
| 15248 | 21471 | Needle Bar Connecting Link with 51002E, for 15374..... |
| 15272 | 21471 | Thread Take-up Cam with 1293C, for 15434 |
| 15277 | 21473 | Shuttle Bobbin Case complete for 125018, Nos. 591F, 592E, 2975, 15141 and 15278. |
| 15278 | 21473 | Shuttle Tension Spring for 15277..... |
| 15279 | 21474 | Feed Dog, 12 teeth (14 teeth to the inch) for 15280, 15316 and 15317.... |
| 15280 | 21474 | Throat Plate (medium needle hole) for 15279..... |
| 15282 | 21471 | Balance Wheel, 2 1/4 in. pulley..... |
| 15287 | 21475 | Bobbin Winder Friction Ring (rubber) for 125327..... |
| 15288 | 21475 | Bobbin Winder Pulley for 125366..... |
| 15297 | 21472 | Feed Rock Shaft..... |
| 15313 | 21471 | Clamp Stop Motion Flanged Bushing with two 462C, for 15314..... |
| 15314 | 21471 | Clamp Stop Motion complete, Nos. 248A, 256B, 2020 and 15313..... |
| 15316 | ----- | Throat Plate, large needle hole, for 15279..... |
| 15317 | ----- | Throat Plate, small needle hole, for 15279..... |
| 15359 | 21479 | Feed Cover Plate..... |
| 15374 | ----- | Needle Bar Connecting Link 15248 with 2052..... |
| 15396 | 21474 | Tension Thread Guard for 15428..... |
| *15404 | ----- | Trade Mark for 125106..... |
| 15405 | ----- | " " Rivet for 125106 (2)..... |
| 15408 | ----- | Face Plate Tension Seat for 15428..... |
| 15410 | ----- | Tension Stud Bushing for 15432..... |
| 15412 | 21474 | Thread Take-up Spring Regulator for 15432..... |
| 15420 | 21473 | Shuttle Race Body 2530 with 2535 and two 662J, for 2528..... |

NUMERICAL LIST OF PARTS

| No. | Plate | Name |
|-------|-------|--|
| 15428 | 21474 | Face Plate Tension Seat 15408 with 15395, for 15432..... |
| 15429 | 21478 | Presser Foot (needle hole on right hand side) for stitching on edge and inserting braid..... |
| 15432 | 21474 | Face Plate with 857B, 15410, 15412, 15428, 50292B and 125423, for 55644..... |
| 15434 | ----- | Thread Take-up Cam 15272 with 570C and 1520R..... |
| 15445 | ----- | Feed Bar Screw Center 315C with 1519J (2)..... |
| 15471 | ----- | Tension complete for 55644, Nos. 1560B, 13710, 15238, 32572, 50291W, 55645 and two 2102..... |
| 15486 | 21471 | Presser Bar Lifter Hinge Stud for 125106 |
| 15492 | 21471 | Thread Take-up Lever with 1822 and 50527C..... |
| 15498 | 21471 | Arm Shaft Bushing for 125106..... |
| 23258 | 21378 | Controller Resistance Unit Screw Washer (steel) for 194491 to 194493 and 194569 to 194571..... |
| 25510 | 21478 | Braider..... |
| 25525 | 21479 | Bias Gauge..... |
| 25527 | 21477 | Cloth Guide for 120309..... |
| 25537 | 21477 | Screw Driver Machine for 120309..... |
| 25637 | 21479 | Under Braider Foot..... |
| 25693 | 21478 | Hemmer Foot for 1/4 in. hem..... |
| 25978 | 21478 | Presser Foot (single toe) for gathering. |
| 26075 | 21471 | Thread Cutter and Holder..... |
| 26399 | 21479 | Corder Bow complete..... |
| 26538 | ----- | Embroidery Attachment complete for one thread..... |
| 32572 | 21474 | Tension Releasing Disc for 15471..... |
| 32672 | 21471 | Balance Wheel, 3 1/4 in. pulley, for 15-97 Machine..... |
| 35002 | 21479 | Presser Foot Extension for 121718..... |
| 35003 | 21479 | " " Graduated Adjustable Guide (long, left) for 121718..... |
| 35004 | 21479 | Presser Foot Graduated Adjustable Guide (long, right) for 121718..... |
| 35005 | 21479 | Presser Foot Graduated Adjustable Guide (short, right) for 121718..... |
| 35006 | 21479 | Presser Foot Graduated Adjustable Guide (short, right) flush, for 121718.... |
| 35135 | 21479 | Presser Foot Graduated Adjustable Guide Clamp for 121718..... |
| 35206 | 21479 | Presser Foot Graduated Adjustable Guide Clamp Lever for 121718..... |
| 35505 | ----- | Embroidery Attachment complete for two threads..... |

| No. | Plate | Name |
|---------|-------|---|
| 35931 | 21477 | Hemmer (adjustable) for 120309..... |
| 35932 | 21478 | Quilter..... |
| 35985 | ----- | Tubular Trimming Attachment complete.... |
| 36058 | 21478 | Presser Foot with 665B and 36059 for blind stitch cording to turn small curves..... |
| 36059 | 21478 | Presser Foot Cord Guide for 36058..... |
| 36067 | 21478 | " " for braiding, for art work, for braid 1/16 in. to 3/16 in. wide. |
| 36583 | 21477 | Tucker complete for 120309..... |
| 36835 | 21478 | Feller (foot)..... |
| 36865 | ----- | Edge Stitcher..... |
| 45319 | 21474 | Presser Foot Plate for 45321..... |
| 45320 | 21474 | " " Shank for 45321..... |
| 45321 | 21474 | Presser Foot (hinged) complete, Nos. 45319, 45320 and 45329..... |
| 45329 | 21474 | Presser Foot Hinge Pin for 45321..... |
| 45845 | 21475 | Bobbin Winder Tension Disc for 125396... |
| 45846 | 21475 | " " Screw Washer for 125396..... |
| 45847 | 21475 | Bobbin Winder Tension Disc Spring for 125396..... |
| 50053B | 21477 | Cloth Guide Thumb Screw for 120309..... |
| 50291W | 21474 | Tension Stud for 15471..... |
| 50292B | 21474 | " " Set Screw for 15432..... |
| 50353E | 21471 | Feed Regulator Hinge Screw..... |
| 50527C | 21471 | Thread Take-up Lever Hinge Screw for 15492..... |
| 50564J | 21480 | Singerlight Nipple Cap Set Screw for 193936..... |
| 50566 | 21480 | Singerlight Lead Terminal Screw (brass) for 194592 (2)..... |
| 506320R | 20207 | Motor Bracket Screw for 193287..... |
| 51002E | 21471 | Needle Bar Connecting Link Adjusting Screw for 15248..... |
| 51045C | 21471 | Machine Hinge Connection Set Screw..... |
| 51093R | 21378 | Three-Pin Terminal (female half) Housing Screw for 194521 and 194533 (2).... |
| 51104B | 21477 | Binder Folder Screw for 121464..... |
| 51119J | 20213 | Controller Bracket Screw (2)..... |
| 51119R | 20215 | " " Clamp Screw for 198164 (3)..... |
| 51203 | 21480 | Singerlight Lamp Contact Lead Terminal Screw (brass) for 194594 and 194607. |
| 51203 | 21480 | Singerlight Toggle Switch Spring Contact (right) Screw (brass) for 194594 and 194607..... |
| 51206R | 20207 | End Cover Screw (2)..... |
| 51207C | 20207 | Pulley Position Screw..... |
| 51208B | 20207 | Motor Screw for 193287..... |

| No. | Plate | Name |
|---------|-------|---|
| 51224B | 21471 | Arm Side Cover Thumb Screw..... |
| 51224B | 21474 | Presser Foot Thumb Screw..... |
| 51224TM | 20211 | Knee Lever Extension Thumb Screw for 194430..... |
| 51225B | 21471 | Feed Regulator Thumb Screw..... |
| 51228ZJ | 21471 | Pressure Regulating Thumb Screw for 66773..... |
| 51229E | 21472 | Shuttle Driver Cushion Spring Screw for 125064 (2)..... |
| 51282J | 21474 | Shuttle Race Slide Spring Screw for 15147..... |
| 51290 | ----- | Singerlight Lead Terminal Screw (brass) for 194605..... |
| 51303R | 21475 | Bobbin Winder Stop Latch Hinge Screw for 125327..... |
| 51319R | 21475 | Bobbin Winder Frame Hinge Screw for 125327..... |
| 51327J | 21378 | Controller Resistance Unit Short Circuit- ing Contact Screw..... |
| 51340C | 21378 | Controller Resistance Unit Bell Crank Hinge Screw for 194418 and 194422... |
| 51340C | 21378 | Controller Resistance Unit Yoke Hinge Screw for 194418..... |
| 51385CR | 21480 | Singerlight Toggle Switch Shell Screw for 194592 and 194605..... |
| 51395W | 21479 | Ruffler Shirring Plate Thumb Screw for 121170..... |
| 51399K | 21480 | Singerlight Toggle Switch Frame Screw for 194594 and 194607..... |
| 51582 | 20207 | Three-Pin Terminal Body (male half) Post Thumb Nut for 192797 (3)..... |
| 51602R | 21480 | Singerlight Nipple Nut for 194305 and 194306..... |
| 55621 | 21471 | Presser Bar Lifter..... |
| 55644 | 21474 | Face Plate complete, Nos. 15432 and 15471 |
| 55645 | 21474 | Thread Take-up Spring for 15471..... |
| 56814 | ----- | Feed Lifting Rock Shaft Screw Center 307C with 1513J (2)..... |
| 56814 | ----- | Feed Rock Shaft Screw Center 307C with 1513J (2)..... |
| 56814 | ----- | Oscillating Rock Shaft Screw Center 307C with 1513J (2)..... |
| 66601 | 21475 | Bobbin Winder Frame Spring for 125327... |
| 66670 | 21475 | " " for 125366..... |
| 66752 | 21471 | Pressure Regulating Thumb Screw Plug (felt) for 66773..... |
| 66773 | ----- | Pressure Regulating Thumb Screw 51228ZJ with 66752..... |

NUMERICAL LIST OF PARTS

| No. | Plate | Name |
|-------|-------|---|
| 66775 | 21475 | Bobbin Winder Stop Latch Spring for 125327..... |
| 80011 | 21471 | Presser Bar Spring..... |
| 80028 | 21476 | Hand Attachment Pinion Dowel Pin for 94052, for 15-98 Machine..... |
| 94016 | 21476 | Hand Attachment Gear Cover for 94052, for 15-98 Machine..... |
| 94027 | 21476 | Hand Attachment Body Bracket for 94052, for 15-98 Machine..... |
| 94028 | 21476 | Hand Attachment Crank Handle (wood) for 94034, for 15-98 Machine..... |
| 94029 | 21476 | Hand Attachment Crank Handle Spindle for 94034, for 15-98 Machine..... |
| 94030 | 21476 | Hand Attachment Crank Handle Spindle Flange (loose) for 94034, for 15-98 Machine..... |
| 94031 | 21476 | Hand Attachment Crank Lever for 94034, for 15-98 Machine..... |
| 94032 | 21476 | Hand Attachment Crank Lever Lock Pin for 94051, for 15-98 Machine..... |
| 94033 | 21476 | Hand Attachment Crank Lever Lock Pin Head for 94051, for 15-98 Machine... |
| 94034 | ----- | Hand Attachment Crank complete for 94052, for 15-98 Machine, Nos. 94028 to 94031..... |
| 94036 | 21476 | Hand Attachment Driver Finger for 94041, for 15-98 Machine..... |
| 94037 | 21476 | Hand Attachment Driver Finger Latch for 94052, for 15-98 Machine..... |
| 94038 | 21476 | Hand Attachment Driver Finger Latch Spring for 94052, for 15-98 Machine. |
| 94039 | 21476 | Hand Attachment Driver Finger Driving Pad (rawhide) for 94041, for 15-98 Machine..... |
| 94040 | 21476 | Hand Attachment Driver Finger Driving Pad Plate for 94041, for 15-98 Ma- chine..... |
| 94041 | ----- | Hand Attachment Driver Finger 94036 with SS567E, 94039 and 94040, for 94052, for 15-98 Machine..... |
| 94044 | 21476 | Hand Attachment Driver Finger Hinge Pin for 94052, for 15-98 Machine..... |
| 94046 | 21476 | Hand Attachment Driver for 94052, for 15-98 Machine..... |
| 94048 | 21476 | Hand Attachment Pinion for 94052, for 15-98 Machine..... |
| 94050 | 21476 | Hand Attachment Body for 94052, for 15-98 Machine..... |
| 94051 | 21476 | Hand Attachment Gear with 8282, 94032 and 94033, for 94052, for 15-98 Ma- chine..... |

NUMERICAL LIST OF PARTS

| No. | Plate | Name |
|--------|-------|---|
| 94052 | 21476 | Hand Attachment complete for 15-98 Ma- chine, Nos. SS565E, SS566C, SS599F, SS600F, 80028, 94016, 94027, 94034, 94037, 94038, 94041, 94044, 94046, 94048, 94050, 94051, 94069 and two each 183E and 399A..... |
| 94069 | 21476 | Hand Attachment Crank Hinge Pin for 94052, for 15-98 Machine..... |
| 97359 | 21480 | Singerlight Screw Retaining Washer (fibre) for 193294 and 193518..... |
| 120309 | ----- | Attachment Set Nos. 8879, 25527, 25537, 35931, 36583, 50053B, 120378, 120842, 121464 and five 2518, for 120603.... |
| 120329 | ----- | Machine Cover (Accessories)..... |
| 120378 | 21477 | Screw Driver (shuttle tension) for 120309..... |
| 120565 | 21477 | Binder Folder Screw Washer for 121464... |
| 120603 | 21477 | Attachment Set complete, Nos. 120309 and 120598..... |
| 120687 | 21478 | Hemstitcher with Yielding Presser Plate. |
| 120842 | 21477 | Hemmer Foot (flat bottom) for 5/64 in. hem for 120309..... |
| 120882 | 21479 | Oil Can, contents 1 1/3 fl. oz. (filled with household oil)..... |
| 121079 | ----- | Singercraft Guide complete..... |
| 121094 | ----- | Darning Foot (spring) complete..... |
| 121170 | 21479 | Ruffler Shirring Plate (universal) with 51395W..... |
| 121255 | ----- | Singercraft Fagoter complete..... |
| 121387 | ----- | Hemstitching and Picoting Attachment complete..... |
| 121441 | 21478 | Presser Foot (double toe) for gathering. |
| 121461 | 21477 | Binder Folder for 121464..... |
| 121463 | 21477 | " Foot for 121464..... |
| 121464 | 21477 | Binder complete for 120309, Nos. 51104B, 120565, 121461 and 121463..... |
| 121547 | 21479 | Under Braider..... |
| 121634 | ----- | Needle Threader and Seam Ripper complete |
| 121706 | ----- | Zigzag Attachment (adjustable) complete. |
| 121717 | 21479 | Presser Foot for 121718..... |
| 121718 | 21479 | Presser Foot with Extension and Gradu- ated Adjustable Guides complete, Nos. 337D, 35002 to 35006, 35135, 35206 and 121717..... |
| 121725 | 21478 | Finger Guard..... |
| 121795 | ----- | Buttonhole Attachment complete..... |
| 125018 | 21473 | Shuttle, 1 11/16 in. diam., Nos. 2515, 2518 and 15277..... |
| 125021 | 21471 | Crank Connecting Rod with 125044 and two 896C..... |

| No. | Plate | Name |
|---------|-------|---|
| 125035 | 21478 | Presser Foot (needle hole on left hand side) for stitching on edge and inserting braid..... |
| 125042 | 21471 | Arm Shaft..... |
| 125044 | 21471 | Crank Connecting Rod Oil Pad (felt) for 125021..... |
| 125045 | 21471 | Feed Cam and Counterbalance with 1285C.. |
| 125046 | 21471 | " Forked Connection for 125085..... |
| 125047 | 21471 | " " " Slide Block for 125335..... |
| 125052 | 21471 | Needle Bar Bushing..... |
| 125055 | 21472 | Oscillating Rock Shaft with 125056..... |
| 125056 | 21472 | " " " Oil Wick (braided cotton) for 125055..... |
| 125057 | 21472 | Oscillating Shaft Crank for 125059..... |
| 125059 | ----- | " " " 125057 with 125330 and two 462C..... |
| 125061 | 21471 | Presser Bar..... |
| 125064 | 21472 | Shuttle Driver with 125065 and two each 462C and 51229E..... |
| 125065 | 21472 | Shuttle Driver Cushion Spring for 125064 |
| 125068 | 21475 | Bobbin Winder Spindle with 15072, for 125366..... |
| 125072 | 21471 | Needle Bar Bushing Oil Pad (felt)..... |
| 125079 | 21471 | " Bar..... |
| 125080 | 21473 | Shuttle Race Back Spring for 2528..... |
| 125085 | ----- | Feed Forked Connection 125046 with 125335..... |
| 125095 | 21471 | Needle Bar Thread Guard..... |
| 125101 | 21471 | Feed Regulator..... |
| 125103 | 21471 | Stitch Indicator..... |
| 125104 | 21471 | " " Plate..... |
| *125106 | ----- | Arm with 435C, 448C, 15404, 15486, 15498 and two 15405..... |
| *125107 | ----- | Bed..... |
| 125324 | 21475 | Bobbin Winder Bracket (belt cover) for 125327..... |
| 125326 | 21475 | Bobbin Winder Tripping Arm for 125327... |
| 125327 | 21475 | Bobbin Winder complete for Balance Wheel No. 15282 or No. 32672, Nos. 190R, 15287, 51303R, 51319R, 66601, 66775, 125324, 125326, 125366 and 125376... |
| 125330 | 21472 | Oscillating Shaft Crank Slide Block with Stud for 125059..... |
| 125331 | 21471 | Arm Oil Pad (felt) for oiling Arm Shaft Back Bearing..... |
| 125333 | 21471 | Arm Oil Pad Spring..... |
| 125334 | 21471 | " " " Cap..... |
| 125335 | ----- | Feed Forked Connection Slide Block 125047 with 1085E, for 125085..... |

| No. | Plate | Name |
|----------|-------|--|
| 125366 | ----- | Bobbin Winder Frame 66670 with 15288 and 125068, for 125327..... |
| 125376 | 21475 | * Bobbin Winder Stop Latch for 125327..... |
| 125395 | 21475 | " " Tension Bracket for 125396 |
| 125396 | 21475 | Bobbin Winder Tension Bracket complete, Nos. 45845 to 45847, 125396 and 1401382B..... |
| 125422 | ----- | Face Plate Thread Guard for 125423..... |
| 125423 | 21474 | " " " 125422 with 125424, for 15432..... |
| 125424 | ----- | Face Plate Thread Guard Rivet for 125423 |
| 125425 | 21471 | Arm Side Cover..... |
| 136136 | 20211 | Controller Holder with four wood screws 3/8 in. No. 4 R.H.M.F. for Bakelite Controllers No. 194587 to 194589.... |
| 140099R | 21378 | Controller Base Screw for 194583 to 194585 and 194587 to 194589 (4).... |
| 140100R | ----- | Controller Resistance Unit Bell Crank Spring Bracket Screw for 194491 to 194493 and 194569 to 194571 (2).... |
| 140101C | 20212 | Controller Resistance Unit Bell Crank Connecting Link Hinge Screw for 194422..... |
| 140102R | 20212 | Controller Cover Screw for 194381 to 194386 (2)..... |
| 140103R | 21378 | Controller Resistance Unit Screw for 194491 to 194493 and 194569 to 194571 (2)..... |
| 140105TM | 20211 | Knee Lever Connecting Link Hinge Screw for 194431..... |
| 140106J | 20211 | Knee Lever Extension Hinged Bracket Hinge Screw for 194431..... |
| 140107TM | 20211 | Knee Lever Hinge Screw for 194436..... |
| 1401382B | 21475 | Bobbin Winder Tension Screw for 125396.. |
| 140202S | 21471 | Stitch Indicator Plate Screw (2)..... |
| 190058 | 20207 | Motor Bracket Screw Retaining Washer (fibre) for 193287..... |
| 190059 | 20207 | Commutator complete..... |
| 190083 | 20207 | Brush Spring (2)..... |
| 190563 | ----- | Field Coil Retainer..... |
| 190613 | 20207 | Tube filled with Singer Motor Lubricant (packed in carton)..... |
| 190782 | 20207 | Brush (carbon) for 32 to 145 volts (2).. |
| 191097 | 20207 | Armature Thrust Washer (commutator end) fibre..... |
| 191098 | 20207 | Armature Thrust Washer (pulley end) (peerless paper)..... |
| 191417 | 20207 | Motor Bracket Screw Washer for 193287... |
| 192140 | 21378 | Controller Resistance Unit for 95 to 145 volts for 194492 and 194570..... |

NUMERICAL LIST OF PARTS

| No. | Plate | Name |
|---------|-------|--|
| 192141 | ----- | Controller Resistance Unit for 150 to 250 volts for 194493 and 194571..... |
| 192142 | 20211 | Controller Lead Bushing (for Machine Lifting Plate) for Stand No. 46913... |
| 192143 | 20215 | Controller Lead Bushing Retaining Spring for 192142, for Stand No. 46913..... |
| 192211 | ----- | Controller Resistance Unit for 32 to 55 volts for 194491 and 194569..... |
| 192240 | ----- | Field Coil Tube (paper)..... |
| 192641 | 20207 | Motor Bracket for 193287..... |
| 192692 | ----- | Three-Pin Terminal (female half) Insert Clamp for 194521 and 194533 (3)..... |
| 192797 | 20207 | Three-Pin Terminal Body (male half) complete, Nos. three each 51582 and 701719..... |
| 192851 | ----- | Lead Cord complete with Three-Pin Terminal (female half) from lamp socket to Three-Pin Terminal for knee or treadle control..... |
| 192866 | 20213 | Controller Pitman Rod Connection..... |
| 192912 | 20215 | " Lead Tube for Stands Nos. 46909 and 46912..... |
| 192912 | 20215 | Controller Lead Tube (long) for Stand No. 46913..... |
| 192918 | 20211 | Controller Lead Tube Clamp..... |
| 192947 | ----- | Brush Carbon for 150 to 250 volts (2)... |
| 193066 | 20207 | Belt (moulded) for Spoked Balance Wheel No. 15282..... |
| 193077 | ----- | Belt (moulded) for Disc Balance Wheel No. 32872..... |
| 193228 | 20207 | Brush Tube (2)..... |
| 193229 | 20207 | " Cap (2)..... |
| 193230 | 20207 | Armature Shaft Bearing Sleeve Cap (commutator end)..... |
| 193231 | 20207 | Pulley (moulded)..... |
| 193236 | 20207 | Fan..... |
| 193238 | 20207 | Brush Tube Terminal (2)..... |
| 193241 | 20207 | Field Core complete..... |
| 193242 | 20207 | " " Insulation..... |
| *193251 | ----- | Singerlight Lamp Contact Plunger Bushing for 194596..... |
| *193252 | ----- | Singerlight Lamp Contact Plunger Spring for 194594 and 194607 (2)..... |
| *193253 | ----- | Singerlight Lamp Contact Plunger for 194594 and 194607..... |
| *193254 | ----- | Singerlight Lamp Contact Lead Terminal for 194594..... |
| *193255 | ----- | Singerlight Toggle Switch Spring Contact Lead Terminal Stud for 194596..... |
| *193256 | ----- | Singerlight Toggle Switch Spring Contact Lead Terminal for 194594..... |

NUMERICAL LIST OF PARTS

| No. | Plate | Name |
|---------|-------|---|
| *193257 | ----- | Singerlight Toggle Switch Spring Contact (right) for 194594 and 194607..... |
| *193258 | ----- | Singerlight Toggle Switch Spring Contact (left) for 194594 and 194607..... |
| *193259 | ----- | Singerlight Toggle Switch Contact for 194659..... |
| *193267 | ----- | Singerlight Shade Position Pin for 194594 and 194607 (2)..... |
| *193271 | ----- | Singerlight Toggle Switch Flash Disc for 194606..... |
| 193272 | 21480 | Singerlight Shade for 193421..... |
| *193276 | ----- | " Toggle Switch Spring Contact Lead Terminal Plate for 193635..... |
| *193278 | ----- | Singerlight Lamp Contact Lead Terminal Plate for 193634..... |
| 193287 | 20207 | Motor Bracket complete, Nos. 50632CR, 51208B, 190058, 191417, 192641 and 701513..... |
| 193289 | 21480 | Singerlight Lead complete for 193294..... |
| 193294 | 21480 | Singerlight (moulded, less lamp) complete, Nos. 691J, 97359, 193289, 193421, 193437, 193941, 194592, 701909 and two 193509..... |
| 193294 | ----- | Singerlight (moulded, less lamp) complete, Nos. 691J, 97359, 193421, 193437, 193941, 194605, 198240, 701909 and two 193509..... |
| 193294 | ----- | Singerlight (moulded, less lamp) complete, Nos. 691J, 97359, 193421, 193437, 193941, 194605, 198122, 701909 and two 193509..... |
| 193294 | ----- | Singerlight (moulded, less lamp) complete, Nos. 691J, 97359, 193421, 193437, 193941, 194605, 425001, 701909 and two 193509..... |
| 193294 | ----- | Singerlight (moulded, less lamp) complete, Nos. 691J, 97359, 193421, 193437, 193941, 194592, 198131, 701909 and two 193509..... |
| 193318 | 20207 | Armature complete for B.R. 6 and B.R. 7 Motors..... |
| 193384 | 21378 | Controller Resistance Unit Short Circuiting Contact..... |
| *193387 | ----- | Singerlight Toggle Switch Toggle Lever for 194659..... |
| 193401 | 21480 | Singerlight Shade Reflector for 193421.. |
| 193421 | 21480 | " " 193272 with 193401 for 193294 and 193518..... |
| 193437 | 21480 | Singerlight Shade Friction Washer for 193294 and 193518..... |

| No. | Plate | Name |
|---------------|-------|---|
| 193440 | ----- | Field Coil complete for B.R. 3 Motor.... |
| 193443 | ----- | Field Coil complete for B.R. 5 Motor.... |
| 193446 | ----- | Field Coil complete for B.R. 6 Motor.... |
| 193449 | 20207 | Field Coil complete for B.R. 7 Motor.... |
| 193452 | ----- | Field Coil complete for B.R. 8 Motor.... |
| 193455 | ----- | Field Coil complete for B.R. 9 Motor.... |
| 193458 | ----- | Field Coil complete for B.R. 10 and B.R. 11 Motors..... |
| 193461 | ----- | Field Coil complete for B.R. 12 Motor.... |
| 193464 | ----- | Field Coil complete for B.R. 15 Motor... |
| 193467 | ----- | Field Coil complete for B.R. 87 Motor... |
| 193470 | ----- | Field Coil complete for B.R. 90 Motor... |
| 193473 | ----- | Field Coil complete for B.R. 92 Motor... |
| 193476 | ----- | Armature complete for B.R. 3 Motor..... |
| 193477 | ----- | Armature complete for B.R. 5 Motor..... |
| 193478 | ----- | Armature complete for B.R. 8 Motor..... |
| 193479 | ----- | Armature complete for B.R. 9 Motor..... |
| 193480 | ----- | Armature complete for B.R. 10 and B.R. 92 Motors..... |
| 193481 | ----- | Armature complete for B.R. 11 and B.R. 12 Motors..... |
| 193482 | ----- | Armature complete for B.R. 15 Motor..... |
| 193483 | ----- | Armature complete for B.R. 87 Motor..... |
| 193484 | ----- | Armature complete for B.R. 90 Motor..... |
| *193495 | ----- | Singerlight Bracket for 193941..... |
| 193509 | 21480 | " Nipple Washer (felt) for 193294 and 193518 (2)..... |
| 193512 | 21480 | Singerlight Nipple Insulating Collar for 194305 and 194306..... |
| 193518 | 21480 | Singerlight (moulded, less lamp) com- plete, Nos.691J,97359,193421,193437, 193941,194022,194592,701909 and two 193509..... |
| 193518 | ----- | Singerlight (moulded, less lamp) com- plete, Nos.691J,97359,193421,193437, 193941,194605,198246,701909 and two 193509..... |
| (Switzerland) | | |
| 193518 | ----- | Singerlight (moulded, less lamp) com- plete, Nos.691J,97359,193421,193437, 193941,194605,198127,701909 and two 193509..... |
| (Denmark) | | |
| 193518 | ----- | Singerlight (moulded, less lamp) com- plete, Nos.691J,97359,193421,193437, 193941,194605,198119,701909 and two 193509..... |
| (V.D.E.) | | |
| 193518 | ----- | Singerlight (moulded, less lamp) com- plete, Nos.691J,97359,193421,193437, 193941,194592,198318,701909 and two 193509..... |
| (Australia) | | |
| *193633 | ----- | Singerlight Lamp Contact Lead Terminal for 193634..... |

| No. | Plate | Name |
|---------|-------|---|
| *193633 | ----- | Singerlight Toggle Switch Spring Contact Lead Terminal for 193635..... |
| *193634 | ----- | Singerlight Lamp Contact Lead Terminal Plate 193278 with 193633, for 194607 |
| *193635 | ----- | Singerlight Toggle Switch Spring Contact Lead Terminal Plate 193276 with 193633, for 194607..... |
| *193765 | ----- | Singerlight Toggle Switch Toggle Lever Spring Washer for 194659..... |
| 193828 | 20215 | Controller Pitman Rod Connection for Stand No. 46913..... |
| 193829 | 21480 | Singerlight Lead Strain Relief Disc for 194592..... |
| 193908 | 20212 | Controller Lead Clamp for 194491 to 194493..... |
| 193936 | 21480 | Singerlight Nipple Cap 193937 with 50564J, for 194592 and 194605..... |
| *193937 | ----- | Singerlight Nipple Cap with 193938, for 193936..... |
| *193938 | ----- | Singerlight Nipple Cap Insert for 193937 |
| 193939 | ----- | " " for 194306..... |
| 193940 | 21480 | " " for 194305..... |
| 193941 | 21480 | " Bracket 193495 with 193942, for 193294 and 193518..... |
| *193942 | ----- | Singerlight Steady Pin for 193941..... |
| 194022 | 21480 | Singerlight Lead Cord (8 ft. long) and Plug complete for 193518..... |
| 194120 | 21480 | Singerlight Lamp..... |
| 194295 | 20207 | Note: When ordering 194120, state voltage required. End Covers complete, Nos. two each 194326, 194490 and 194494..... |
| *194304 | 21480 | Singerlight Toggle Switch Shell for 194305 and 194306..... |
| *194305 | ----- | Singerlight Toggle Switch Shell 194304 with 51602R, 193512 and 193940 for 194593..... |
| *194306 | ----- | Singerlight Toggle Switch Shell 194304 with 51602R, 193512 and 193939, for 194606..... |
| 194321 | 21378 | Controller Foot Pedal for 194583 to 194585 and 194587 to 194589..... |
| 194322 | 20212 | Controller Base for 194491 to 194493.... |
| 194323 | ----- | " Cover for 194425, 194426 and 194454..... |
| 194324 | 20212 | Controller Resistance Unit Bell Crank Connecting Link for 194422..... |

NUMERICAL LIST OF PARTS

| No. | Plate | Name |
|--|-------|---|
| 194326 | 20207 | Armature Shaft Grease Cup Wick Spring for 194295 (2)..... |
| Nos. 194381 to 194383 for Stands Nos. 46909, 46912 and 46913 | | |
| 194381 | ----- | Controller complete for 32 to 55 volts, A.C. or D.C. Motor, Nos. 194423, 194426, 194491 and two 140102R..... |
| 194382 | 20214 | Controller complete for 95 to 145 volts, A.C. or D.C. Motor, Nos. 194423, 194425, 194492 and two 140102R..... |
| 194383 | ----- | Controller complete for 150 to 250 volts, A.C. or D.C. Motor, Nos. 194423, 194426, 194493 and two 140102R |
| Nos. 194384 to 194386 for Stands No. 25281, 25282 and 25294 | | |
| 194384 | ----- | Controller complete for 32 to 55 volts, A.C. or D.C. Motor, Nos. 194426, 194455, 194491 and two 140102R..... |
| 194385 | 20212 | Controller complete for 95 to 145 volts, A.C. or D.C. Motor, Nos. 194454, 194435, 194492 and two 140102R..... |
| 194386 | ----- | Controller complete for 150 to 250 volts, A.C. or D.C. Motor, Nos. 194426, 194455, 194493 and two 140102R |
| 194399 | ----- | Controller Bracket for 194468..... |
| 194402 | 21378 | " Resistance Unit Bell Crank Spring Bracket for 194418 and 194422 |
| 194404 | 21378 | Controller Resistance Unit Bell Crank Spring for 194569 to 194571 (2)..... |
| 194407 | 21378 | Controller Base Cushion (rubber) for 194583 to 194585, 194587 to 194589 (4)..... |
| 194416 | 21378 | Controller Resistance Unit Bell Crank for 194418 and 194422..... |
| 194418 | ----- | Controller Resistance Unit Bell Crank Spring Bracket 194402 with 194416, 194773 and two each 1607J and 51340C, for 194569 to 194571..... |
| 194421 | 20212 | Controller Resistance Unit Bell Crank Spring for 194491 to 194493 (2)..... |
| 194422 | ----- | Controller Resistance Unit Bell Crank Spring Bracket 194402 with 51340C, 140101C, 194324, 194416, 194773 and two 1607J, for 194491 to 194493..... |
| 194423 | 20214 | Controller Lead complete from Controller to Three-Pin Terminal for 194381 to 194383..... |

NUMERICAL LIST OF PARTS

| No. | Plate | Name |
|--------|-------|--|
| 194425 | 20214 | Controller Cover 194323 with 899688 and two 964317, for 194382..... |
| 194426 | ----- | Controller Cover 194323 with 899287 and two 964317, for 194381, 194383, 194384 and 194386..... |
| 194430 | 20211 | Knee Lever with Controller Operating Unit complete for Sets Nos. 40, 47, 50, 56, 401 and 402, Nos. 5480, 51224TM, 194431, 194436 and four wood screws 5/8 in. No. 6 R.H..... |
| 194431 | ----- | Knee Lever Extension Hinged Bracket Frame 194551 with 1550TM, 1708J, 140105TM, 140106J, 194434, 194549 and 194550, for 194430..... |
| 194434 | 20211 | Knee Lever Extension Hinged Bracket Spring for 194431..... |
| 194436 | ----- | Knee Lever 194437 with 1611TM, 140107TM, 194438, 194470 and 194545, for 194430 |
| 194437 | 20211 | Knee Lever for 194436..... |
| 194438 | 20211 | " " Extension for 194436..... |
| 194454 | 20212 | Controller Cover 194323 with 899691 and two 964317, for 194385..... |
| 194455 | 20212 | Controller Lead complete for 194384 to 194386..... |
| 194468 | 20215 | Controller Bracket 194399 with 126R and 1549R, for Stand No. 46913..... |
| 194470 | 20211 | Knee Lever Hinge Screw Washer for 194436 |
| 194479 | 20212 | Controller Lead Clamp Insulation for 194491 to 194493..... |
| 194490 | 20207 | Armature Shaft Grease Cup Wick (felt) for 194295 (2)..... |
| 194491 | ----- | Controller Base 194322 with 23258, 192211, 193908, 194422, 194479, 194774, 194775, two each 140100R, 140103R, 194421, 194514 and 931090, for 194381 and 194384..... |
| 194492 | ----- | Controller Base 194322 with 23258, 192140, 193908, 194422, 194479, 194774, 194775, two each 140100R, 140103R, 194421, 194514 and 931090, for 194382 and 194385..... |
| 194493 | ----- | Controller Base 194322 with 23258, 192141, 193908, 194422, 194479, 194774, 194775, two each 140100R, 140103R, 194421, 194514 and 931090, for 194383 and 194386..... |
| 194494 | 20207 | Armature Shaft Grease Cup Body for 194295 (2)..... |
| 194514 | ----- | Controller Resistance Unit Bell Crank Spring Bracket Screw Insulating Disc for 194491 to 194493 and 194569 to 194571 (2)..... |

| No. | Plate | Name |
|--------|-------|--|
| 194521 | 21378 | Three-Pin Terminal (female half) complete for 194574, Nos. two each 1768R, 51093R and three 192692..... |
| 194533 | ----- | Three-Pin Terminal (female half) complete for 192851, Nos. two each 1768R, 51093R and three 192692..... |
| 194545 | 20211 | Knee Lever Hinge Screw Friction Washer for 194436..... |
| 194546 | 20211 | Controller Lead Tube..... |
| 194549 | 20211 | Knee Lever Connecting Link for 194431... |
| 194550 | 20211 | " " Extension Hinged Bracket for 194431..... |
| 194551 | 20211 | Knee Lever Extension Hinged Bracket Frame for 194431..... |
| 194569 | ----- | Controller Base 194572 with 192211, 194418, 194774, 194775 and two each 23258, 140100R, 140103R, 194404, 194514 and 931090, for 194583 and 194587... |
| 194570 | ----- | Controller Base 194572 with 192140, 194418, 194774, 194775 and two each 23258, 140100R, 140103R, 194404, 194514 and 931090, for 194584 and 194588... |
| 194571 | ----- | Controller Base 194572 with 192141, 194418, 194774, 194775 and two each 23258, 140100R, 140103R, 194404, 194514 and 931090, for 194585 and 194589... |
| 194572 | 20210 | Controller Base for 194569 to 194571.... |
| 194573 | 21378 | " Cover for 194583 to 194585 and 194587 to 194589..... |
| 194574 | 21378 | Controller Lead Cord complete with Three-Pin Terminal (female half) from lamp socket to Three-Pin Terminal and controller for 194583 to 194585..... |
| 194579 | 20210 | Controller Lead Complete for 194587 to 194589..... |
| 194583 | ----- | Controller complete for 32 to 55 volts, A.C. or D.C. Motor, Nos. 194321, 194569, 194573, 194574, 899287, two 964317 and four each 140099R and 194407..... |
| 194584 | 21378 | Controller complete for 95 to 145 volts, A.C. or D.C. Motor, Nos. 194321, 194570, 194573, 194574, 899815, two 964317 and four each 140099R and 194407..... |

| No. | Plate | Name |
|---------|-------|---|
| 194585 | ----- | Controller complete for 150 to 250 volts, A.C. or D.C. Motor, Nos. 194321, 194571, 194573, 194574, 899287, two 964317 and four each 140099R and 194407..... |
| | | Nos. 194587 to 194589 for Electric Cabinet Table Sets Nos. 40, 47, 50, 56, 401 and 402, Convertible for Foot or Knee Control |
| 194587 | ----- | Controller complete for 32 to 55 volts, A.C. or D.C. Motor, Nos. 194321, 194569, 194573, 194579, 899287, two 964317 and four each 140099R and 194407..... |
| 194588 | 20210 | Controller complete for 95 to 145 volts, A.C. or D.C. Motor, Nos. 194321, 194570, 194573, 194579, 899816, two 964317 and four each 140099R and 194407..... |
| 194589 | ----- | Controller complete for 150 to 250 volts, A.C. or D.C. Motor, Nos. 194321, 194571, 194573, 194579, 899287, two 964317 and four each 140099R and 194407..... |
| 194592 | ----- | Singerlight Socket and Switch complete for 193294 and 193518, Nos. 193829, 193936, 194593, two 50566 and three 51385CR..... |
| *194593 | ----- | Singerlight Socket Body 194594 with 194306, for 194592..... |
| 194594 | 21480 | Singerlight Socket Body 194596 with 51399K, 193254, 193256 to 193258, 194659 and two each 51203, 193252, 193253 and 193267, for 194593..... |
| *194596 | ----- | Singerlight Socket Body with 193258 and two 193251, for 194594 and 194607... |
| 194599 | 21480 | Singerlight Toggle Switch Operating Lever for 194659..... |
| 194605 | ----- | Singerlight Socket and Switch complete (V.D.E. Type) for 193294 and 193518, Nos. 193271, 193936, 194606, two 51290 and three 51385CR..... |
| *194606 | ----- | Singerlight Socket Body 194607 with 194306, for 194605..... |
| 194607 | ----- | Singerlight Socket Body 194596 with 51399K, 193257, 193258, 193634, 193635, 194659 and two each 51203, 193252, 193253 and 193267, for 194606..... |

NUMERICAL LIST OF PARTS

| No. | Plate | Name |
|---------|-------|---|
| 194659 | 21480 | Singerlight Toggle Switch complete for 194594 and 194607, Nos. 193259, 193387, 193765, 194599, 194660, 194661 and 194695..... |
| *194660 | ----- | Singerlight Toggle Switch Frame for 194659..... |
| *194661 | ----- | Singerlight Toggle Switch Operating Lever Hinge Pin for 194659..... |
| *194695 | ----- | Singerlight Toggle Switch Toggle Lever Spring for 194659..... |
| 194773 | 21378 | Controller Resistance Unit Yoke for 194418 and 194422..... |
| 194774 | 21378 | Controller Resistance Unit Adjusting Nut for 194491 to 194493 and 194569 to 194571..... |
| 194775 | 21378 | Controller Resistance Unit Adjusting Nut Lock Spring for 194491 to 194493 and 194569 to 194571..... |
| 194967 | ----- | Field Core Shield (moulded) for B.R. 7 Motor..... |
| 194968 | ----- | Field Core Shield (moulded) for all B.R. Motors except B.R. 7 Motor..... |
| 198001 | 20213 | Controller Bracket for Cabinet Tables... |
| 198002 | 20213 | " " " Cover Sets..... |
| 198119 | ----- | Singerlight Flexible Lead Cord (8 ft. long) and Plug complete for V.D.E., for 193518..... |
| 198122 | ----- | Singerlight Lead complete for Denmark for 193294..... |
| 198127 | ----- | Singerlight Flexible Lead Cord (8 ft. long) and Plug complete for Denmark, for 193518..... |
| 198131 | ----- | Singerlight Lead complete for Australia, for 193294..... |
| 198162 | 20215 | Controller Bracket for 198164..... |
| 198163 | 20215 | " " Clamp for 198164..... |
| 198164 | 20215 | " " 198162 with 198163 and three 51119R, for Stands Nos. 46909 and 46912..... |
| 198169 | 20215 | Controller Pitman Rod Connection for Stands Nos. 46909 and 46912..... |
| 198240 | ----- | Singerlight Lead complete for Switzerland for 193294..... |
| 198246 | ----- | Singerlight Flexible Lead Cord (8 ft. long) and Plug complete, for Switzerland, for 193518..... |
| 198318 | ----- | Singerlight Flexible Lead Cord (8 ft. long) and Plug complete for Australia, for 193518..... |
| 425001 | ----- | Singerlight Lead complete for V.D.E., for 193294..... |

NUMERICAL LIST OF PARTS

| No. | Plate | Name |
|---------|-------|---|
| 701400 | 20207 | Armature Thrust Washer (pulley end) fibre..... |
| 701513 | 20207 | Motor Screw Retaining Washer (fibre) for 193287..... |
| 701719 | 20207 | Three-Pin Terminal Body (male half) Post Washer for 192797 (3)..... |
| 701909 | 21480 | Singerlight Nipple Nut Insulating Washer (fibre) for 193294 and 193518..... |
| *899287 | ----- | Name Plate for 194426, 194583, 194585, 194587 and 194589..... |
| *899688 | ----- | Name Plate for 194425..... |
| *899691 | ----- | " " for 194454..... |
| *899815 | ----- | " " for 194584..... |
| *899816 | ----- | " " for 194588..... |
| 931090 | ----- | Controller Resistance Unit Screw Washer (asbestos) for 194491 to 194493 and 194569 to 194571 (2)..... |
| 964317 | ----- | Name Plate Drive Screw for 194425, 194426, 194454, 194583 to 194585 and 194587 to 194589 (2)..... |

Genuine Singer Needles should be used
in Singer Machines.
These Needles and their Containers
are marked with the
Company's Trade Mark "SIMANCO." 1

Needles in Containers marked
"For Singer Machines"
are not Singer made needles. 2

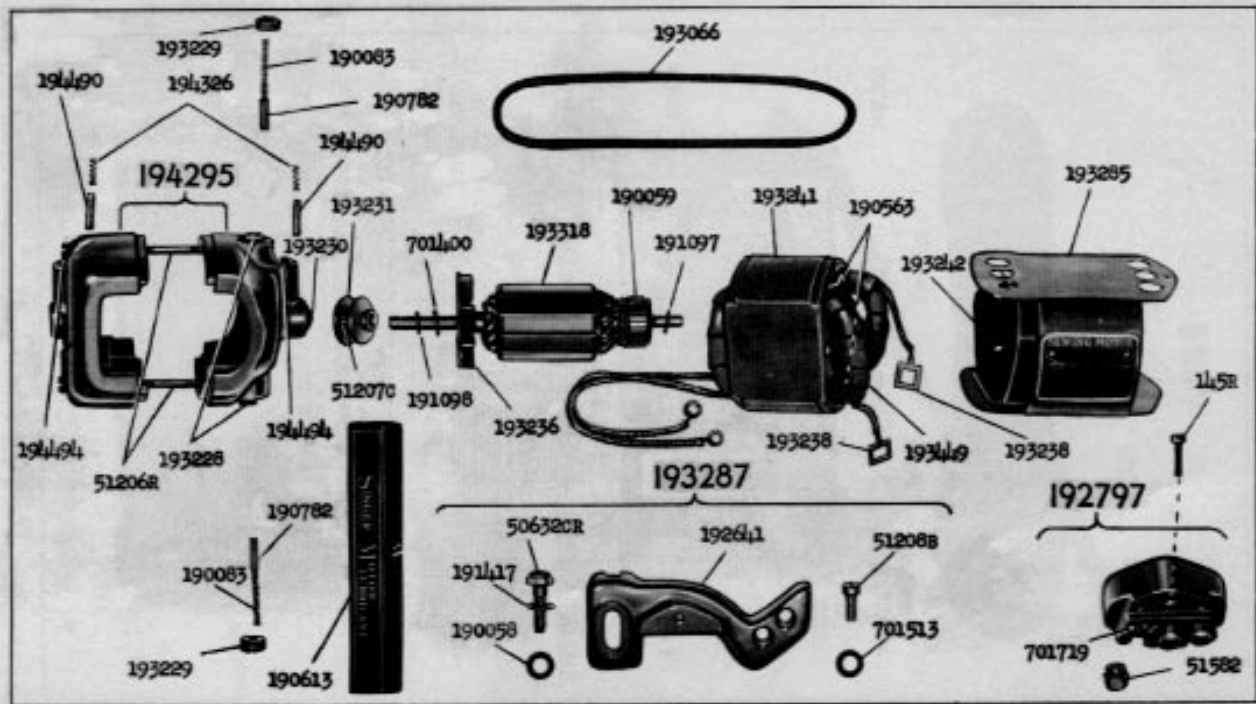

20207 - 1/3

20210 - 1/2

194588

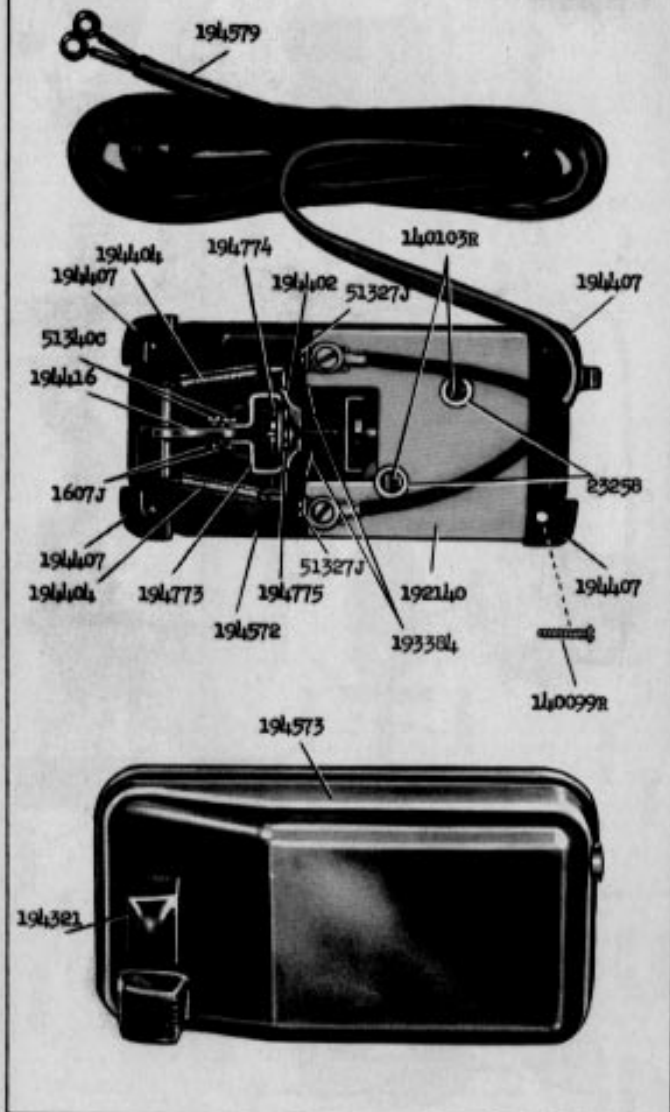

20211 - 1/2

194430

194474

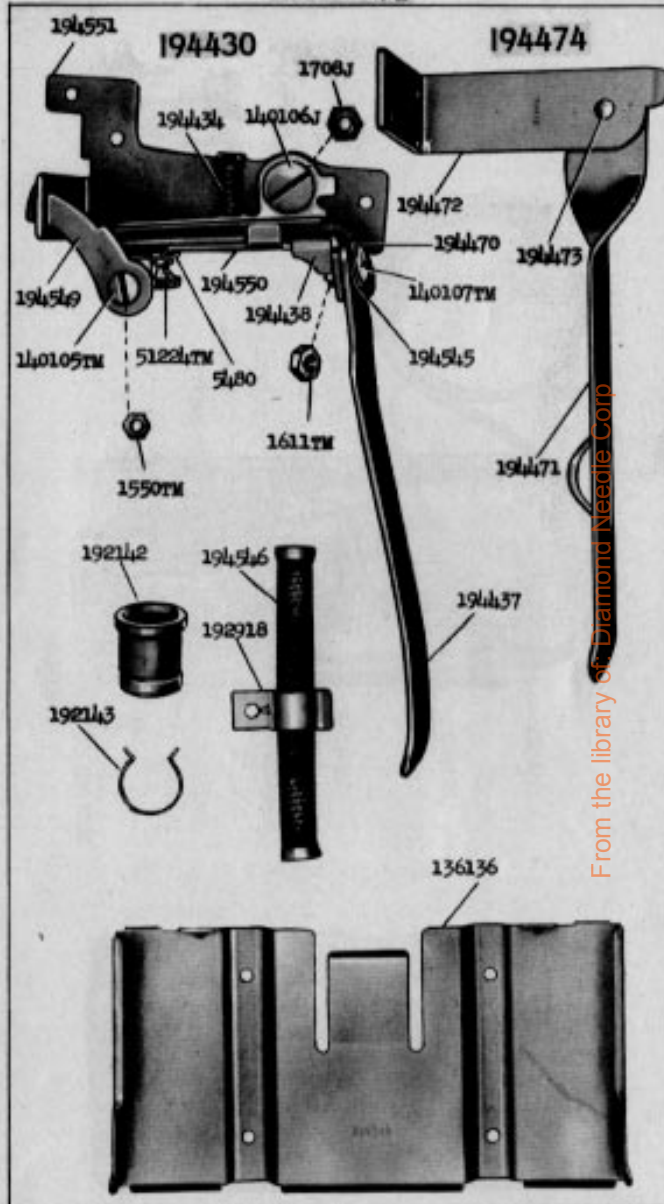

From the library of Diamond Needle Corp

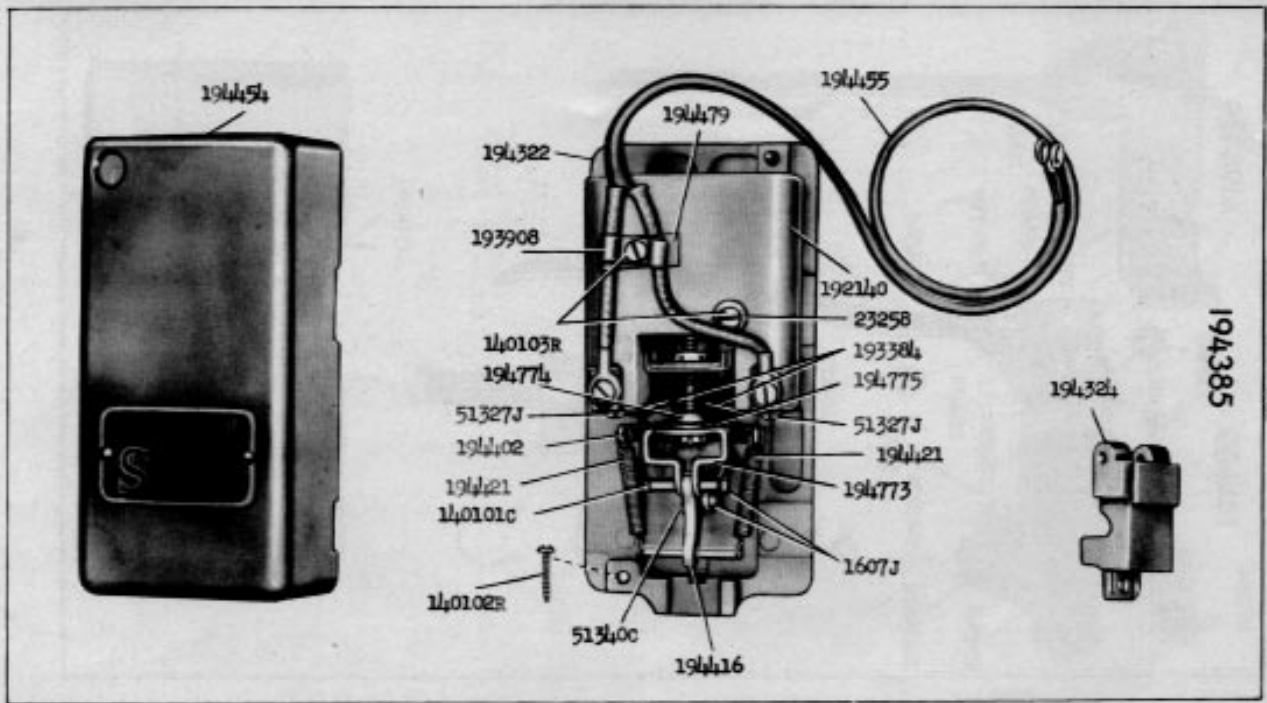

20213 - 2/3

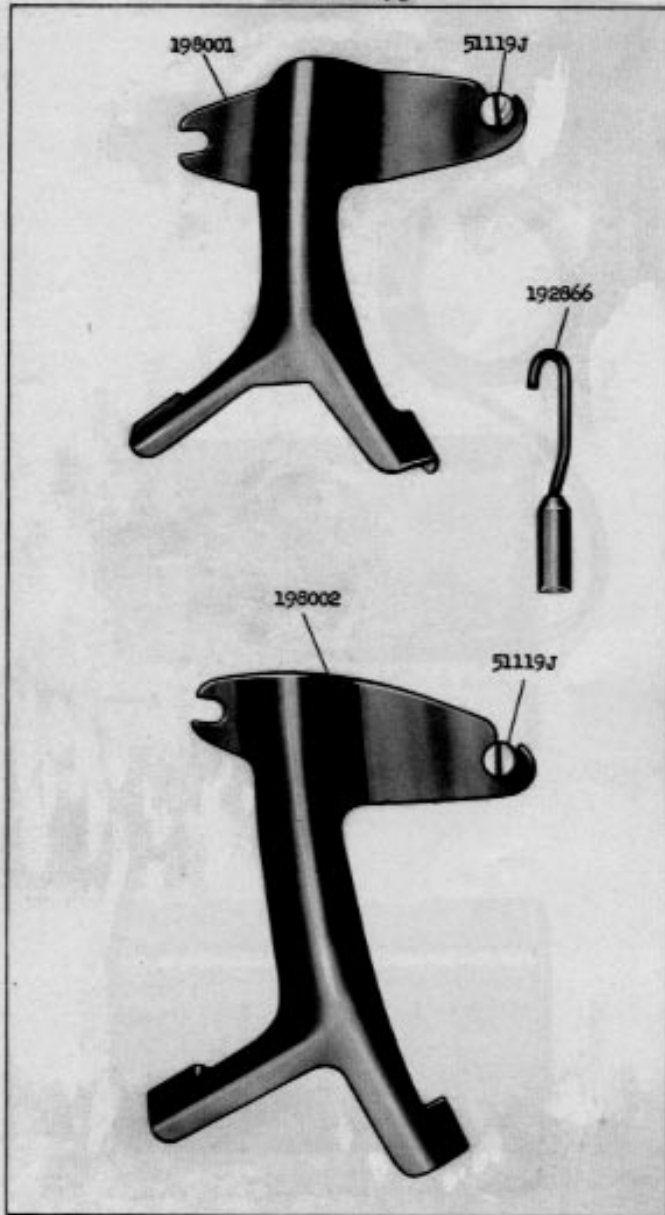

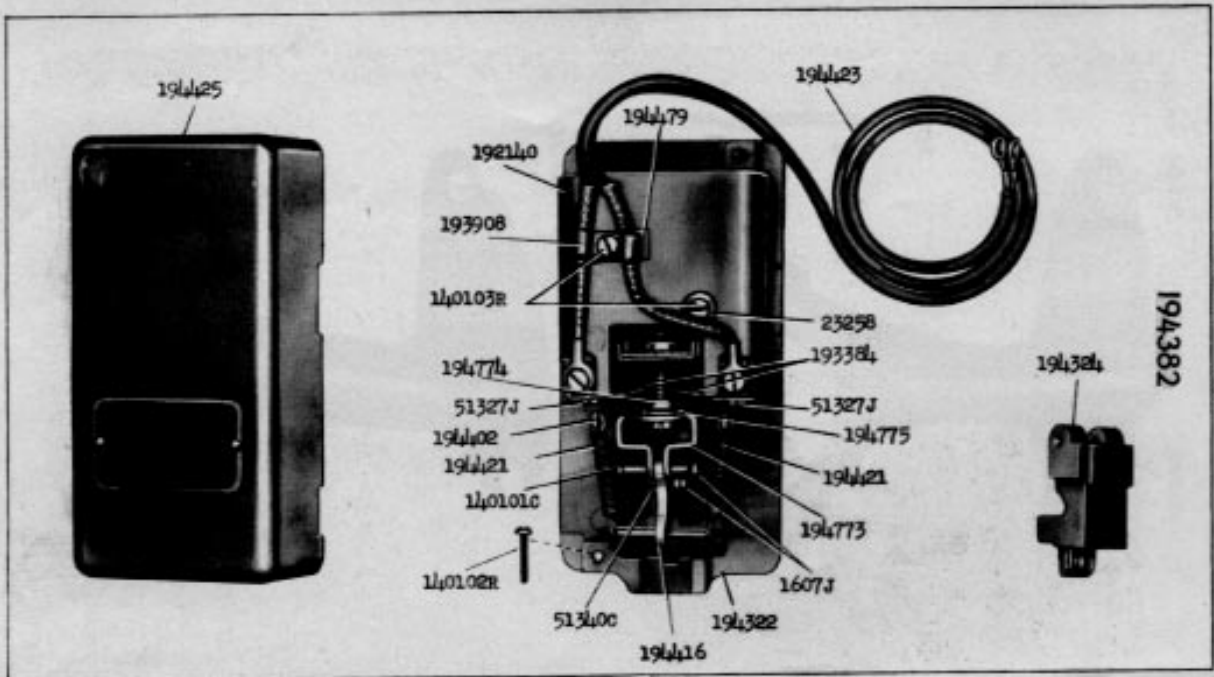

20215 - 1/2

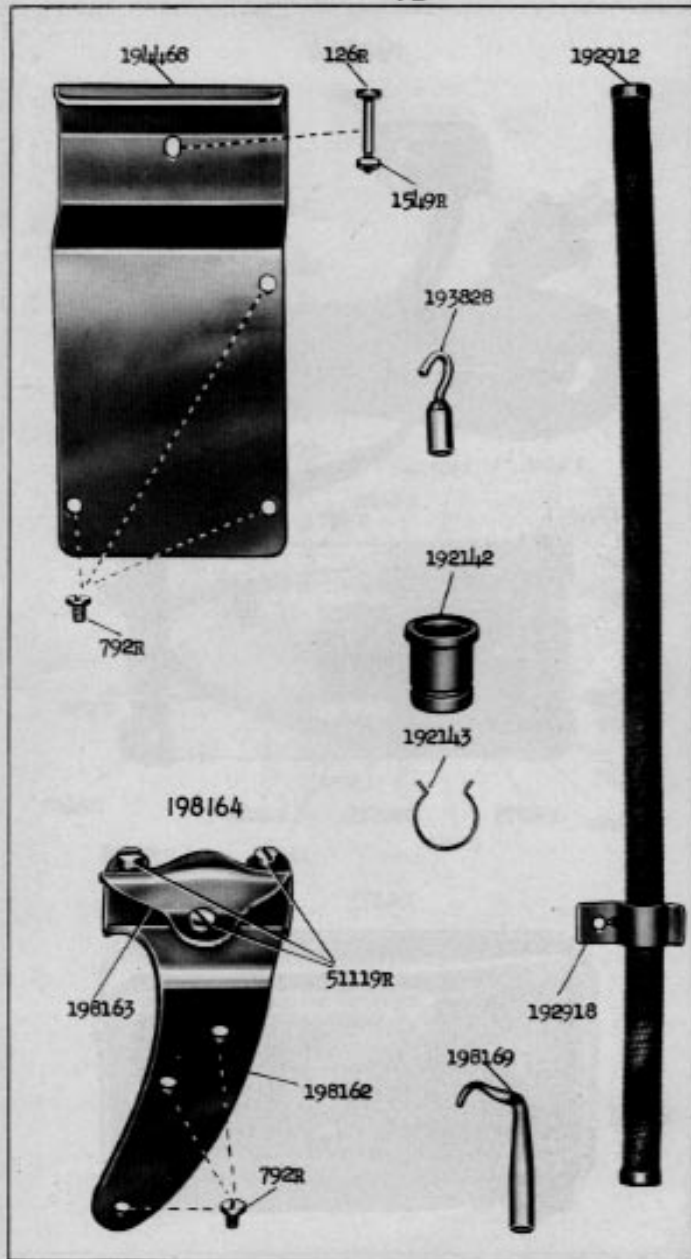

21378 - 1/2

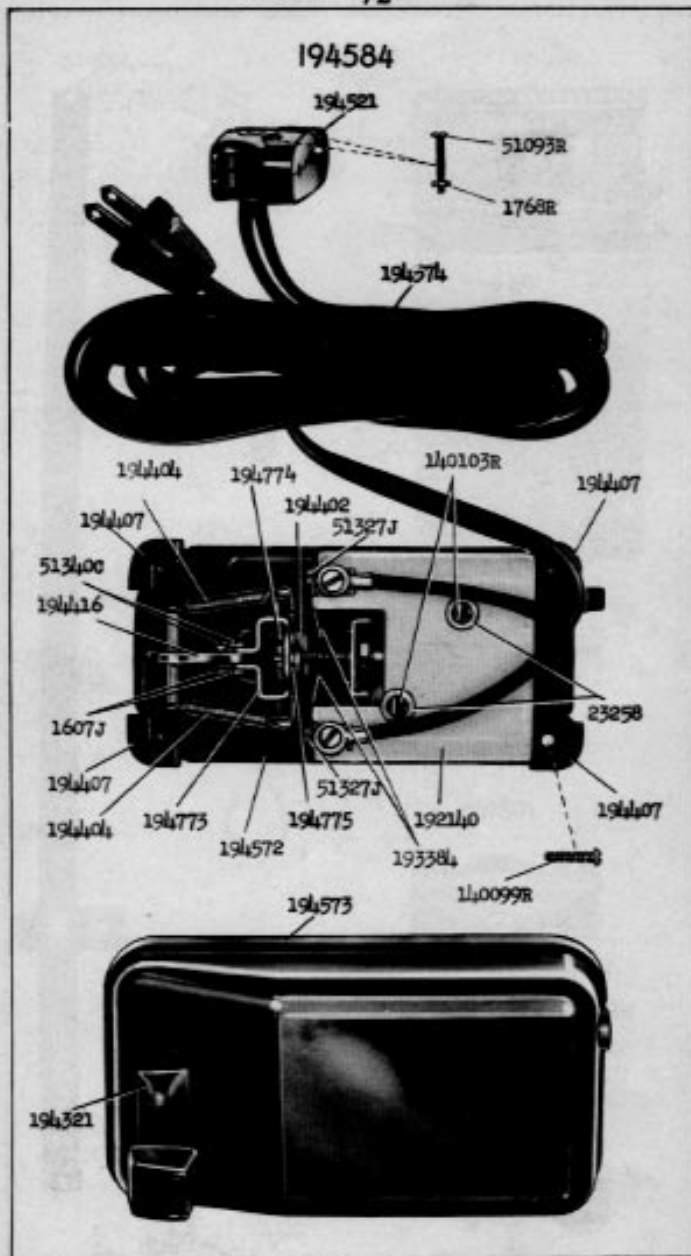

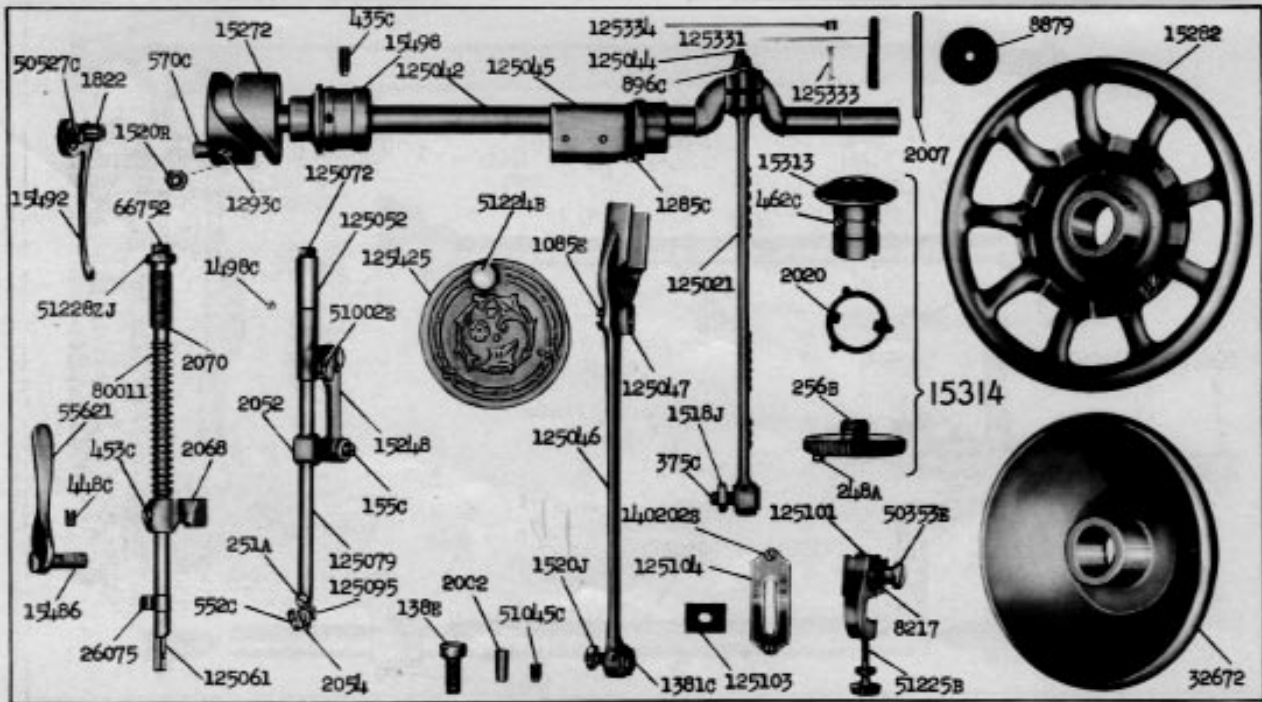

21471 - 1/3

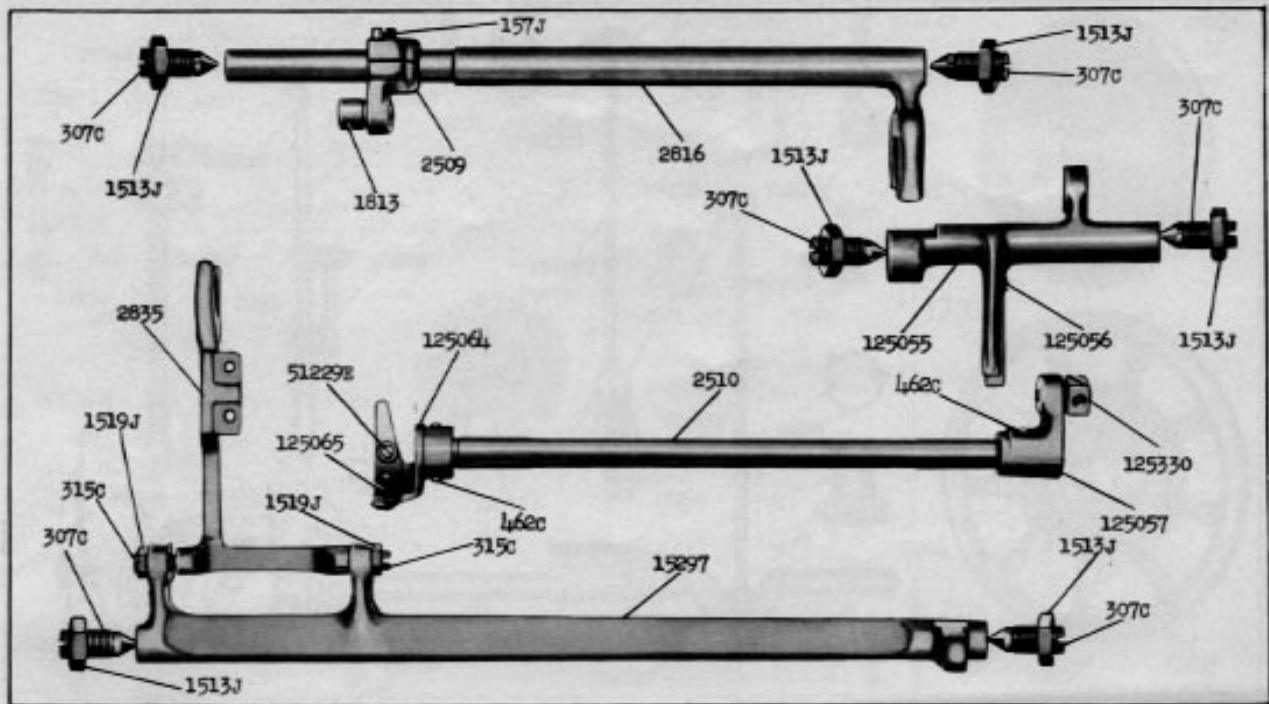

21472 - 1/2

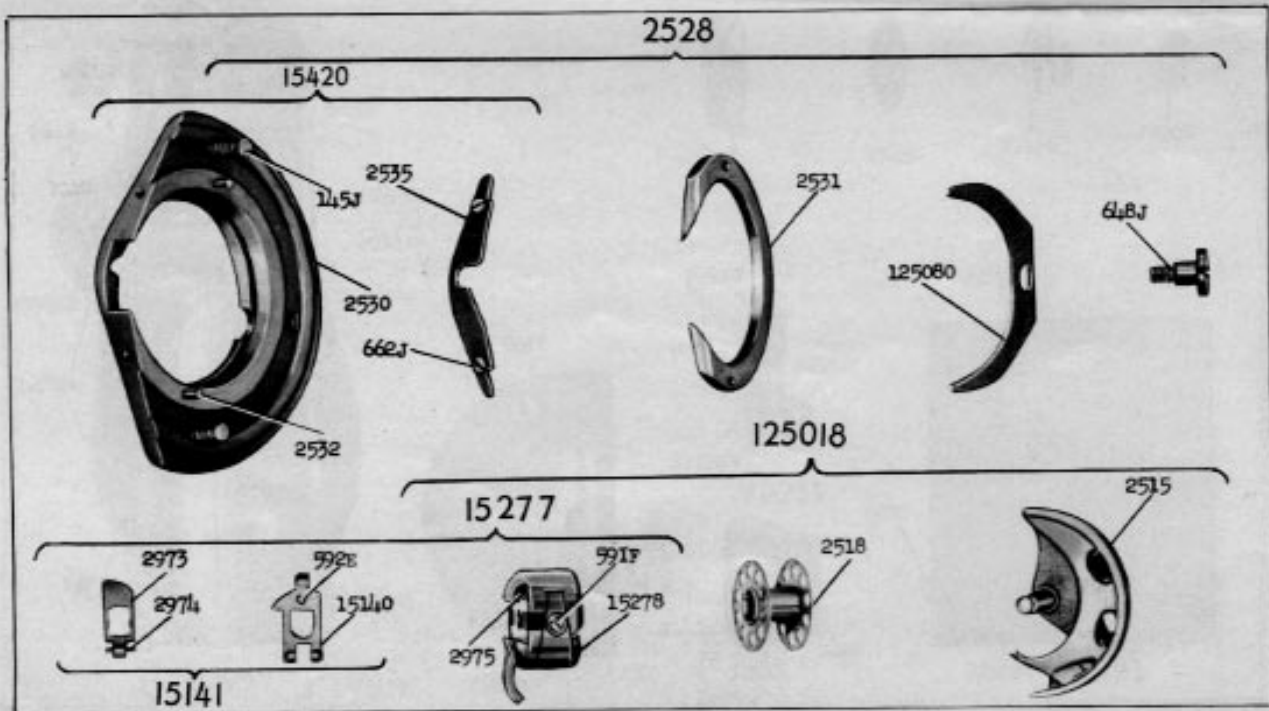

21473 - 2/3

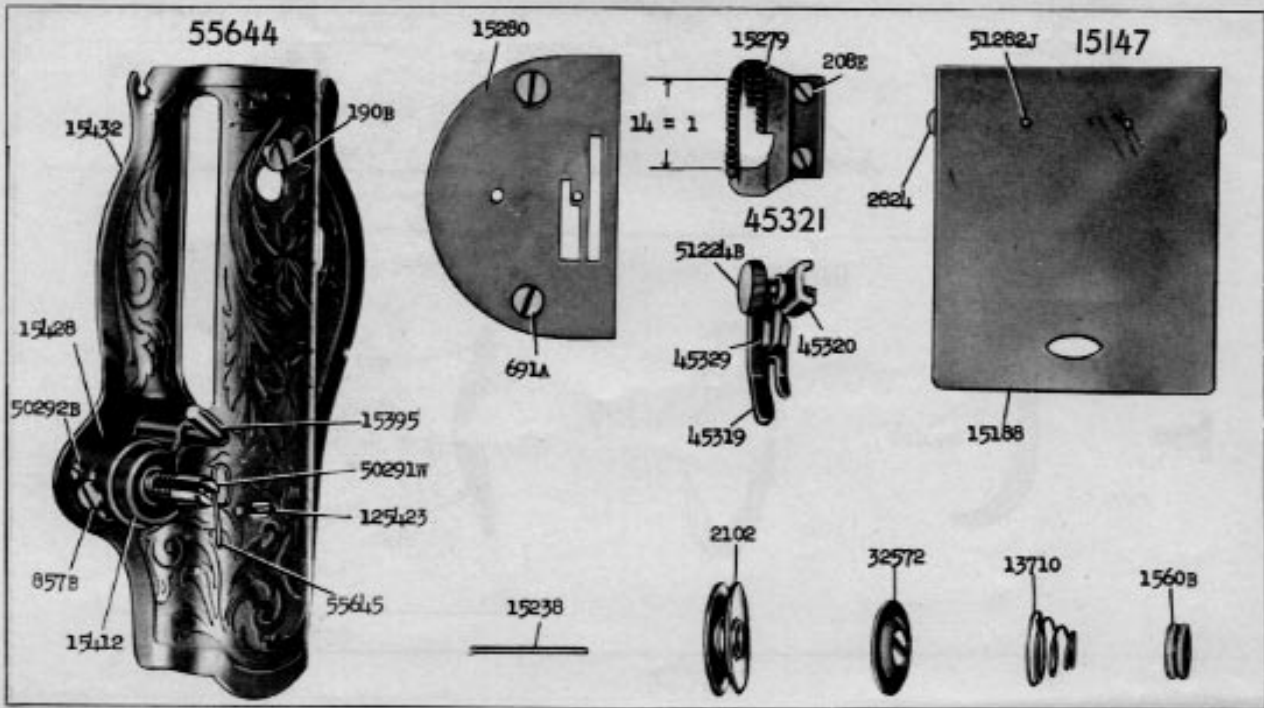

21474 - 2/3

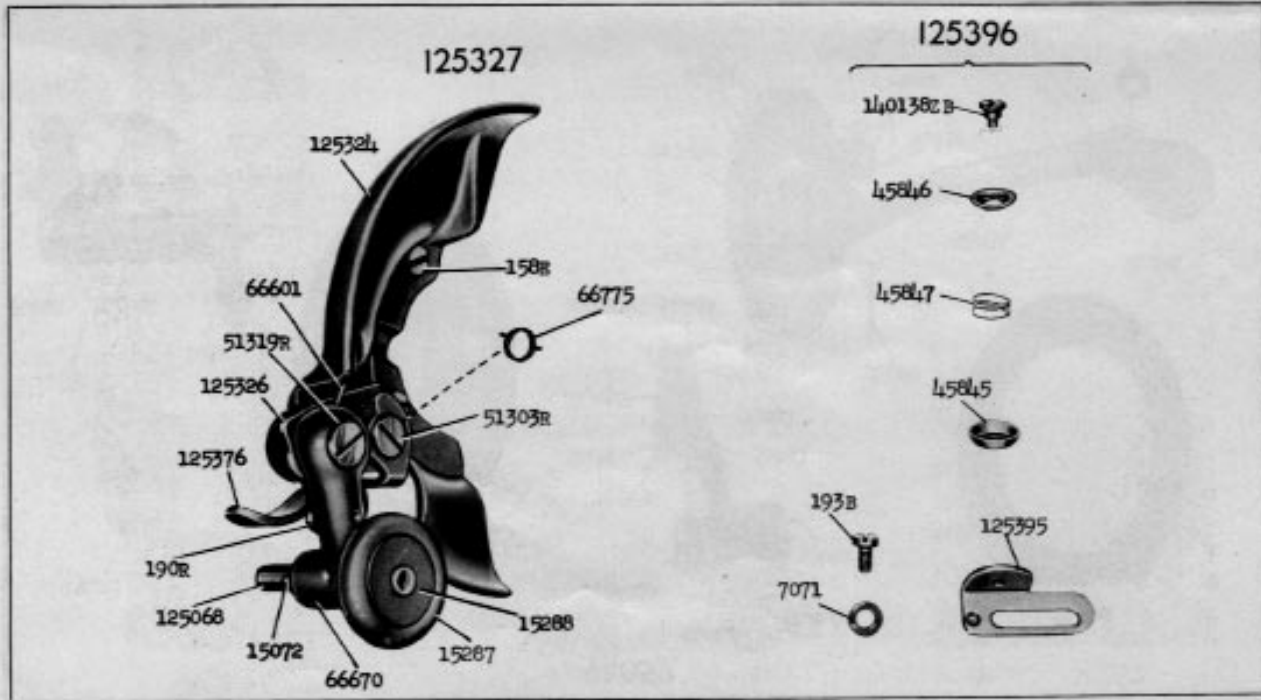

21475 - 2/3

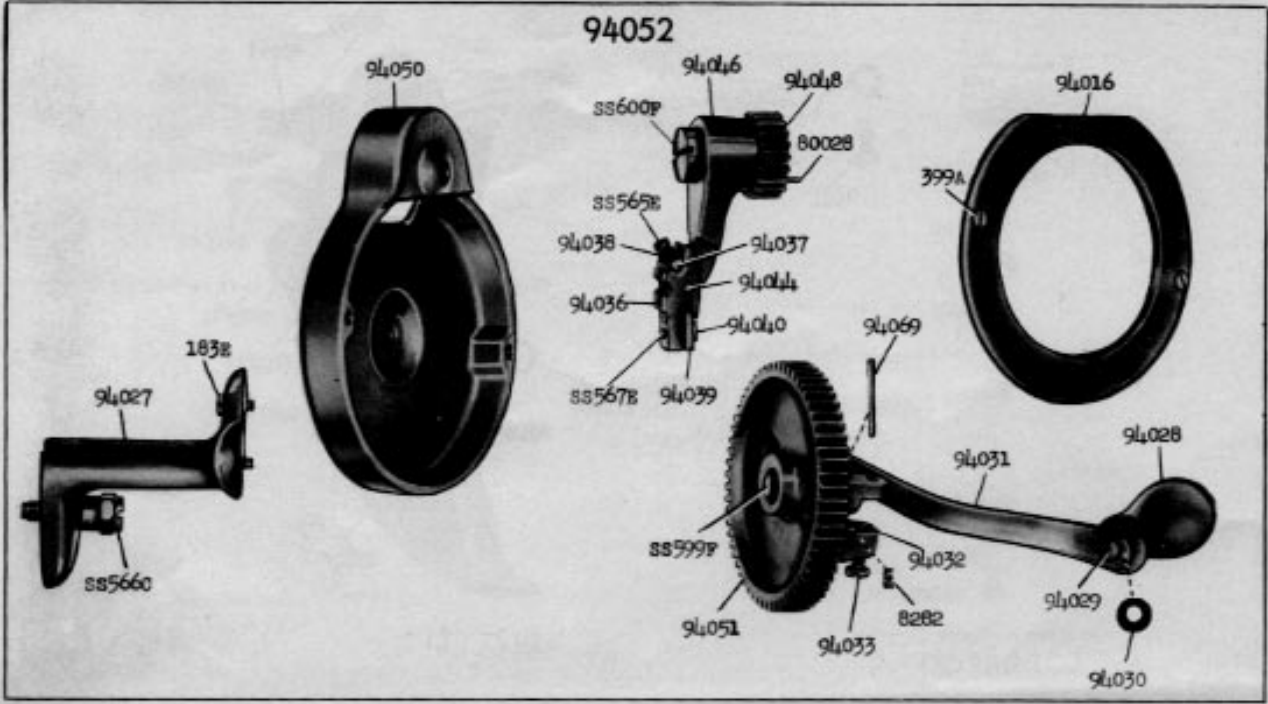

21476 - 1/2

21477 - 1/2

120603

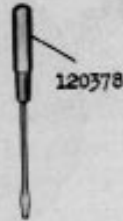
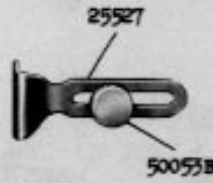
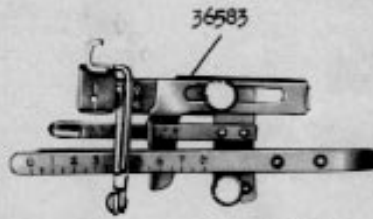
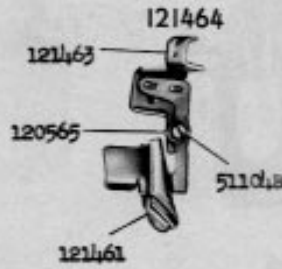
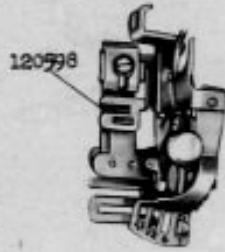

2518



21478 - 1/2

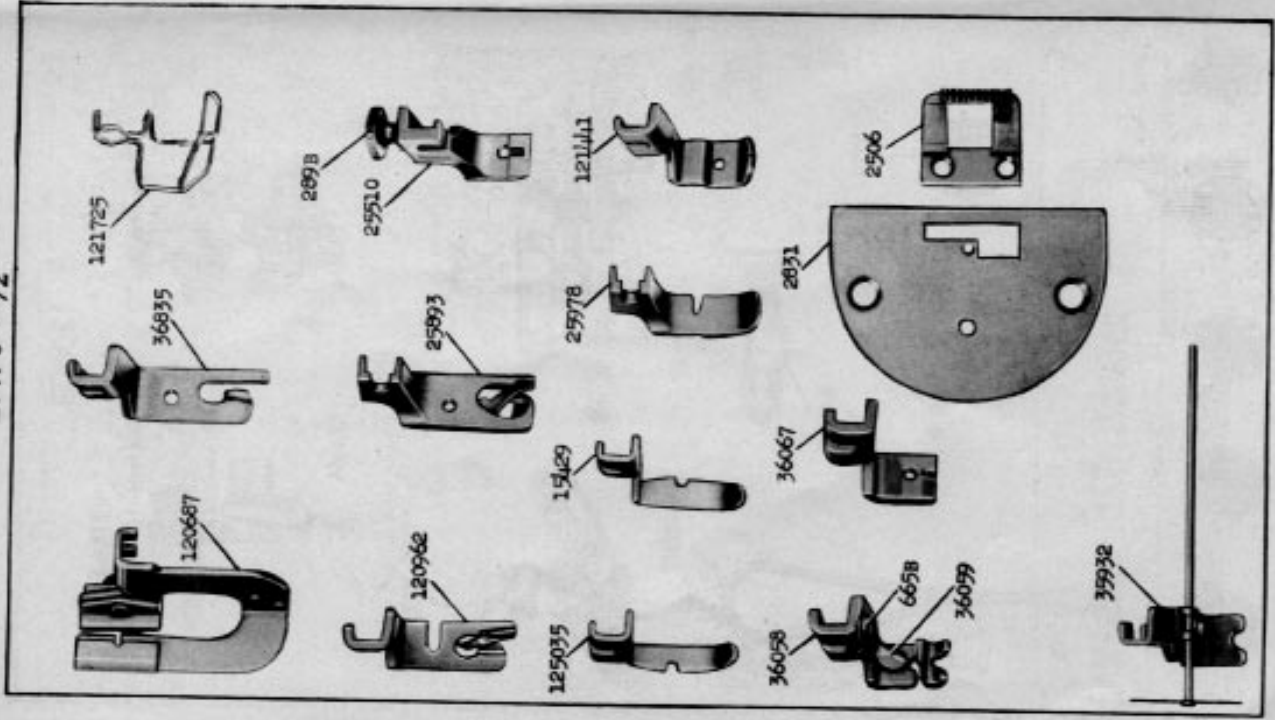

21479 - 1/2

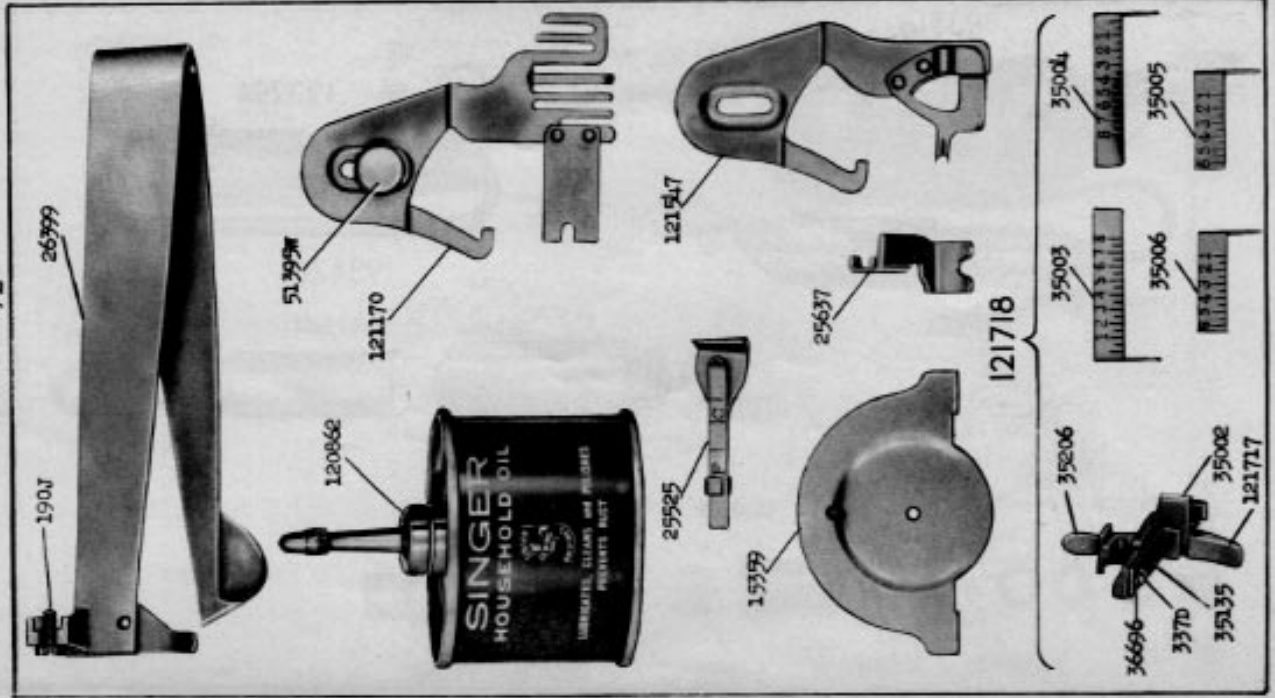

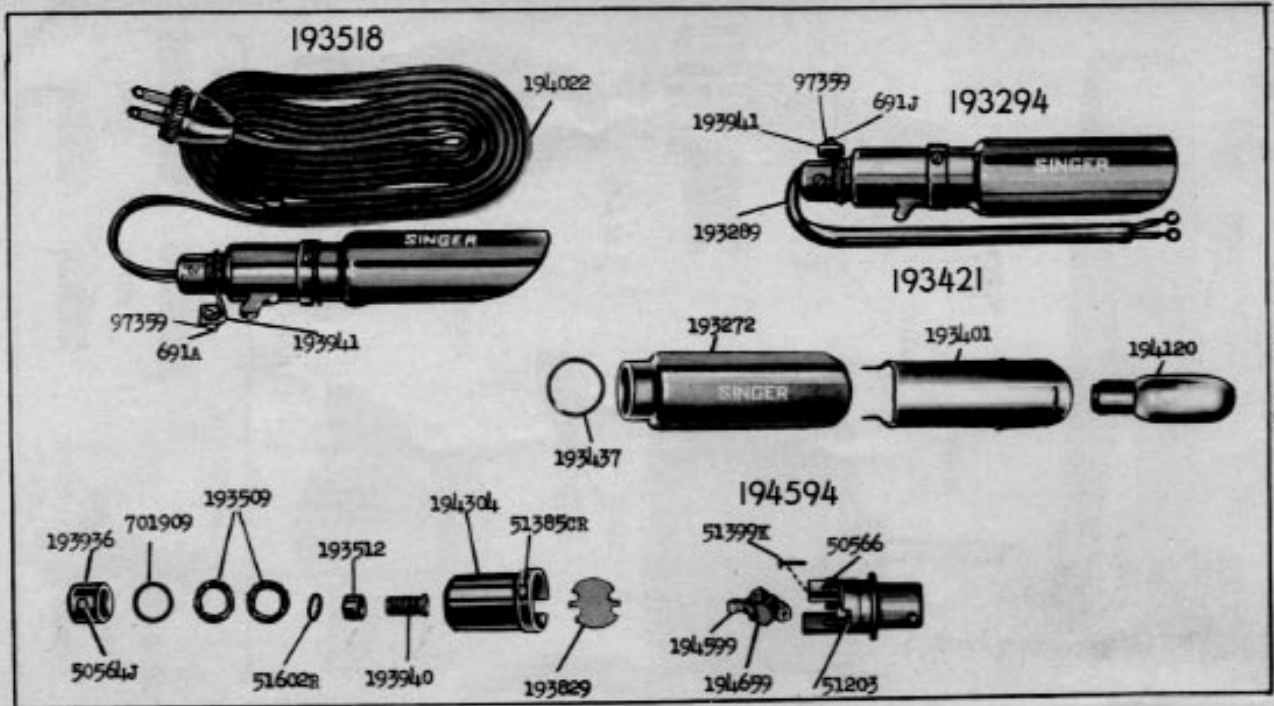

21480 - 1/3